

# Texas Architect



# Are you using Revit?

Yes

No

Do you want a new  
features cheat sheet?

Do you want to see  
a demo of Revit?

Yes

Not  
Sure

Not  
Sure

Yes

## Call (281) 445-6161 Today!!!

**software** • **implementation** • **support**  
**training** • **consulting**

480 N. Sam Houston Pkwy E. , Suite 234, Houston, Texas 77060 P: 281.445.6161



I want my project to  
enhance my community  
and last for many lifetimes

WITH  
**BORAL**  
YOU CAN.



Brick, stone,  
and stucco!

Boral Building Products

Austin: 512.997.9955  
Carrollton: 972.245.1542  
College Station: 979.690.5330  
Henderson: 903.655.2099  
Houston: 281.442.8400

Build something great™

[boralbuildingproducts.com](http://boralbuildingproducts.com)

Brick  
Stone  
EIFS and Stucco  
Hardscapes







*Paving the way for over 25 years.*





FLOORS, TERRACES, POOLS, DRIVEWAYS

# PEACOCK PAVERS™

HANDCRAFTED CONCRETE PAVERS / 800.264.2072 / PEACOCKPAVERS.COM / PATENT PENDING





# ART FOR ALL TIME



SINCE 1929, ARCHITECTS HAVE TREASURED TEXAS QUARRIES STONE for memorable buildings, like Mutual Deposit & Loan Company, completed in 1930 by Hugo Kuehne in Austin. Owners and weather may change, but durable Texas Quarries limestone retains its charm.



Today, we cut stone directly from the earth and shape it with digital precision and subtle artistry. Our light energy use and central Texas shipping are LEED friendly. Rediscover Texas Quarries limestone—the select material for fresh, yet timeless, architecture.



## OUR STORIED LIMESTONE THRIVES PAST EIGHTY



From the earth,  
for the earth.®



CORDOVA  
CREAM  
SMOOTH



CORDOVA  
SHELL  
SMOOTH

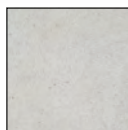

LUEDERS  
SMOOTH

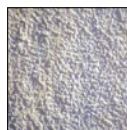

BUSH  
HAMMERED  
LUEDERS



SEA TRACE  
LUEDERS





## Texas Architect

### Articles

- 7** Editor's Note
- 9** Contributors
- 11** Of Note
- 19** Calendar
- 20** Recognition
- 22** Paperwork
- 24** Products
- 28** Essay: Creek Show
- 31** Essay: Why Small?  
*Donna Kacmar, FAIA*
- 89** Profile: Scott Specht, AIA  
Running with X-acto  
*Canan Yetmen*
- 94** Trends and Marketplace
- 96** Backpage

### Featured Projects

- 36** Open House:  
Guest Nest  
*Jen Wong*
- 44** Cabin Fever  
*Jack Murphy, Assoc. AIA*
- 50** Big Ideas  
*Christopher Ferguson, Assoc. AIA*
- 56** Small Is Beautiful  
*Jack Murphy, Assoc. AIA*
- 62** A Bench Is a Bench  
*Ryan Flener, Assoc. AIA*
- 66** Bit by Bit  
*Miriam Sitz*
- 72** Keeping It Compact  
*Lawrence Connolly, AIA*
- 80** A Yellow Pop-Up  
*Rachel Adams*
- 84** Bring Your Own Bag  
*Catherine Gavin*

### More Online

▣ [texasarchitects.org](http://texasarchitects.org)  
Cannonball Run



AIA Austin's Tiny Victories Design Competition

# 65

---

# 01

### Open House

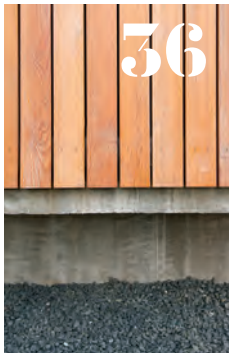

### Tiny

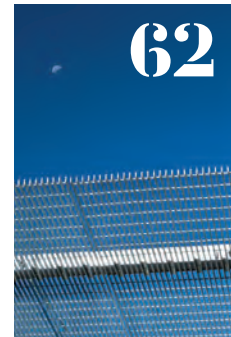

### Profile







photo by Kelly Photography

## 76th Annual Convention and Design Expo Call for Presentations

**If you have an insight, technique, or idea you're eager to share, this is your chance to communicate it to the Texas design industry.**

Texas Architects is now accepting continuing education presentation proposals for our 76th Annual Convention and Design Expo, which will be held in Dallas on November 5 – 7, 2015.

**Submit online**  
[texasarchitects.org/presentations](http://texasarchitects.org/presentations)



**Texas  
Society of  
Architects**

**Texas  
Architect**

January/February 2015  
Volume 65, Number 1

**The Official Publication of the Texas Society of Architects (Texas Architects) *Texas Architect*** (ISSN: 0040-4179) is published six times per year. The Texas Society of Architects is the state component of the American Institute of Architects (AIA). Copyright 2015 by the Texas Society of Architects.

**Catherine Gavin**

Editor  
[editor@texasarchitects.org](mailto:editor@texasarchitects.org)

**Pentagram Austin**

Art Direction

**Monica Cavazos Mendez**

Assistant Editor  
[monica@texasarchitects.org](mailto:monica@texasarchitects.org)

**Elizabeth Hackler**

Designer and Assistant Publisher  
[elizabeth@texasarchitects.org](mailto:elizabeth@texasarchitects.org)

**Courtney James**

Design Intern

**Contributing Editors**

**Lawrence Connolly, AIA, Austin; Stephen Fox, Houston; Val Glitsch, FAIA, Houston; J. Brantley Hightower, AIA, San Antonio; Greg Ibañez, FAIA, Fort Worth; Max Levy, FAIA, Dallas; Michael Malone, AIA, Dallas; Ed Soltero, AIA, El Paso; Bryce A. Weigand, FAIA, Dallas; Frank Welch, FAIA, Dallas; Willis Winters, FAIA, Dallas**

**Krys D'Antonio**

Sales Leader  
[kdantoni@naylor.com](mailto:kdantoni@naylor.com)  
 503 908 1181

**Charlotte Friedley**

Communications & Advertising Specialist  
[charlotte@texasarchitects.org](mailto:charlotte@texasarchitects.org)

**Delia Grey**

Circulation Manager  
[ted@texasarchitects.org](mailto:ted@texasarchitects.org)

**James T. Perry**

Executive Vice President and CEO

**Texas Architects Publications Committee**

**Audrey Maxwell, AIA, Dallas (chair); Eurico R. Francisco, AIA, University Park; Sam Garcia, AIA, McAllen; Murray Legge, FAIA, Austin; Alexis McKinney, AIA, Houston; Ronnie Self, Houston; Margaret Sledge, AIA, San Antonio; Ron Stelmarski, AIA, Dallas; Al York, AIA, Austin**

**Texas Architects Board of Directors**

**Michael Malone, AIA, Dallas, President; Paul Bielamowicz, AIA, Austin, President-elect and Vice President; Fernando Brave, FAIA, Houston, Vice President; Donna Kacmar, FAIA, Houston, Vice President; Mike McGlone, AIA, San Antonio, Vice President; Adam Reed, AIA, San Antonio, Vice President; Darren Heine, AIA, Brenham, Secretary; James Williams II, AIA, Amarillo, Treasurer; Adam Gates, Assoc. AIA, San Antonio, Associate Member Director; Barrie Scardino Bradley, Public Member Director; Elizabeth Danze, FAIA, Austin, Education Member Director; James Nader, FAIA, Fort Worth, AIA Regional Director; Daniel Hart, AIA, Midland, AIA Regional Director; Chris Hudson, AIA, Houston, AIA Regional Director; Bill Noonan, AIA, Abilene Chapter; Jay Bingham, AIA, Amarillo Chapter; Richard Weiss, AIA, Austin Chapter; Elizabeth Price, AIA, Brazos Chapter; Connie Rivera, AIA, Corpus Christi Chapter; Sean Garman, AIA, Dallas Chapter; Carl Daniel Jr., AIA, El Paso Chapter; Matt Green, AIA, Fort Worth Chapter; Perry Seeberger Jr., AIA, Houston Chapter; Christopher Collins, AIA, LRGV Chapter; Mary K. Crites, AIA, Lubbock Chapter; Alan Roberts, AIA, Northeast Texas Chapter; Lowell Tacker, AIA, San Antonio Chapter; Philip Long, AIA, Southeast Texas Chapter; Jane Kittner, AIA, Waco Chapter; Kenneth Dowdy, AIA, Wichita Falls Chapter**

Printed in the U.S.A. Periodicals postage paid at Austin, Texas, and additional mailing offices. Postmaster: Send address changes to *Texas Architect*, 500 Chicon Street, Austin, Texas 78702. Reproduction of editorial content without written permission is prohibited. Contact Circulation Manager for reprint information. Use of names and images of products and services in either editorial or advertising does not constitute an endorsement by the Texas Society of Architects or AIA, nor does comment necessarily reflect an official opinion of either organization. *Texas Architect* is indexed by the Avery Index of Architectural Periodicals.



## Innovation and Design

by Catherine Gavin

*“World Building” presented by Benjamin Rice at the 2013 TxA Interactive conference, was designed to examine the relationship of ecology to collaboration by presenting alternative, estranged nature and its imagery.*

Digital fabrication is turning traditional architectural practice on its head, and as academics press forward into uncharted territories, communication and cross-pollination with practicing architects is increasingly important. In 2013, then president of the Texas Society of Architects Lawrence Speck, FAIA, decided to build a small bridge over this divide.

“As someone who has always had one foot in architecture academia and one foot in architectural practice, it has always been frustrating to me that these two worlds do not have more constant mechanisms for dialogue,” notes Speck. Recognizing the vitality of the digital fabrication world in academia, its rapid advancement, and its relevance to the profession, Speck asked Kory Bieg, assistant professor at The University of Texas at Austin School of Architecture, to bring a number of academics together as part of a peer-reviewed panel, and the 2013 TxA Interactive conference was quickly established and presented in conjunction with the 74th Annual Convention and Design Expo. After a small name change, the second annual conference, now called TxA Emerging Design + Technology, occurred last November in Houston.

Both conferences were somewhat well attended, but clearly the word has not gotten out about the opportunity to learn about the forefront of design theory as one balances checking off compulsory credit-rich ADA sessions at the statewide conference. So in case you missed it, this month academic papers from the 2013 conference will be published digitally and in hard copy. Papers from the 2014 event will follow later this year.

For Bieg, this discussion is highly relevant for practicing architects. “Through advances in digital design, fabrication, and computation, we are beginning to understand architectural geometries in a whole new way,” argues Bieg. “Emerging technologies have opened up new methods for creating, modifying, and describing objects. We can understand objects by more than their basic physical properties, such as color, texture, and size.” And the role of fabrication as a partner in the equation is turning the virtual into reality. For those of you who were intrigued by the Neri Oxman lecture in Houston last November, these academic papers should prove a promising read.

*Catherine Gavin*





# Classic-ISO Steel Windows The Bauhaus Institute Restoration, 2011



When the Brenne Architects in Berlin were tasked to reinvigorate the Bauhaus Institute in Dessau, they wanted an ultra-slim steel window that would keep out water, wind, and ensure great thermal performance while maintaining all the historical functionality of the original design. The only product capable of achieving that came from MHB.

With **1 3/16" wide sightlines, mullions, and structural muntins**, MHB's thermally broken steel profile is the thinnest in the world and is certified to perform great in practically any environment. To learn more, please visit [grandopenings.com/mhb](http://grandopenings.com/mhb)



Dallas  
214.956.7700  
Austin  
512.989.9400

Houston  
713.742.5050  
New Orleans  
504.598.5741

Tyler  
903.920.2327





**Jen Wong** is a regular contributor to *TA* and the director and curator of the University Co-op Materials Lab at The University of Texas at Austin, a multidisciplinary resource center with a primary mission to promote material investigation in design. Read her article about LOJO's recent backyard guesthouse, on page 36.



**Canan Yetmen** is an Austin-based writer who is celebrating 20 years of hanging around the architectural profession and has no plans to stop any time soon. Read her story about Scott Specht, AIA, on page 89.



**Donna Kacmar, FAIA** is a practicing architect and an associate professor at the University of Houston Gerald D. Hines College of Architecture, where she teaches design studio and directs the Materials Research Collaborative. Her recent book, "BIG little house," is to be published by Routledge in March 2015. Read her essay about building small on page 31.



**Rita Catinella Orrell** is our products editor. She has been writing about design for over 18 years, covering architecture, interior design, home furnishings, kitchen and bath design, and building products. She was the products editor for *Architectural Record* for 14 years and was the founding editor of SNAP, a quarterly building products magazine. She currently writes about product design at [www.designythings.com](http://www.designythings.com) and [www.architectstoybox.com](http://www.architectstoybox.com). Check out her selection of green products featured on page 24.



**Jack Murphy, Assoc. AIA** is currently a designer with Baldrige Architects in Austin and a contributing editor to *BI* ([bipublications.com](http://bipublications.com)). He received his Bachelor of Science in Architectural Design from MIT, where he completed a semester on exchange at TU Delft. He wrote two articles about tiny, sustainable houses for this issue. Read them on pages 44 and 56.



**Lawrence Connolly, AIA** lives and works in Austin's Tarrytown neighborhood. He has appreciated the new campus of The Girls' School of Austin since construction began. Read his article about the school on page 72.



**Ryan Flener, Assoc. AIA** received his B. Arch. in 2010 from the University of Tennessee College of Architecture & Design, where he was heavily influenced by the historical relationships between body and building, music, and the craft of montage — alternatives to the computational world. Read his article about the Kidd Springs Park Pavilion in Dallas on page 62.



**Max Levy, FAIA** appreciates the small things in life. Read his thoughts on his favorite aspect of the Venice Architecture Biennale — a Carlos Scarpa-designed room, which he happened upon during his visit — on page 11.



**Rachel Adams** is an independent curator and writer in Austin. She is the curator-in-residence at Disjecta Contemporary Art Center of Portland, planning the 2014–2015 exhibition season that involves the intersection of art and architecture. She has written for publications such as [www.artforum.com](http://www.artforum.com), Arts + Culture Texas, Modern Painters, and *TA*. Read her article about G:Model on page 80. ■



• NARROW SIGHTLINES  
 • NATURAL PATINA FINISHES  
 • FACTORY GLAZED

**ELEGANCE FOR THE EXCEPTIONALLY SELECTIVE**

[solidbronzewindows.com](http://solidbronzewindows.com)

**R**  
 RENAISSANCE  
 SOLID BRONZE  
 WINDOWS & DOORS

**Need timber framing?**  
 You just found your dream source.



From outdoor living spaces to 20,000 sq. ft. frames.  
 We do it all.

Tour Our Facility. Order Free Catalog.

877-680-1680 | [texas timberframes.com](http://texas timberframes.com)  
 613 Highway 46 East | Boerne, TX 78006



**WinDoor**  
 INCORPORATED

**Inspiring Architects One Project -At - A-Time**

Impact Resistant Doors & WinDow Systems by WinDoor have been designed with knowledge gained from years of understanding the needs of coastal markets.



We offer a variety of custom Sliding Glass Doors - WinDows & Terrace Doors systems available in ...

Aluminum - Thermally Broken Aluminum & Vinyl Products sizes to fit any new home, high rise or remodeling project.

For Specifications & DWG Files Go to our web

**[WWW.WinDoorInc.com/ArchitecturalGuide](http://WWW.WinDoorInc.com/ArchitecturalGuide)**

Or Contact our Sales & Marketing Dept.

**407.481.8400**







**Above** A figure of Fortune holds a wind vane along the shores of the Bacino di San Marco in Venice.

### **Ispirazione**

by Max Levy, FAIA

Here's a bit of a switch from my Dallas routine. In amber morning light, I board a *vaporetto* (water bus) and float down Venice's Grand Canal. Because this city is without cars, one can hear the water lapping at the hull and at the stone foundations lining the waterways. We glide out into the Bacino di San Marco, a vast jade lagoon that is the world's most operatic setting of aquatic urbanism. Its shore is defined by

ancient architecture punctuated emphatically with works by Palladio and Longhena. This scene is animated by the slow-motion trajectories of gondolas, service craft, and suave mahogany water taxis. Presiding over it all is an enormous gold-leafed wind vane, surmounted by a figure of Fortune that has been pivoting for centuries above the old customs house.

I disembark at the Arsenale, the medieval shipyards from which the Crusades were launched. Entering the slender gable end of a 1,000-ft-long 16th-century former rope factory, I walk its length through a colonnade of 40-ft-tall cylindrical brick columns. Inside this and several other Arsenale buildings, and in the pavilions of the nearby Giardini (public gardens), are the exhibits of the 14th Venice Architecture Biennale. Architectural sensory overload is assured. But somewhere in this lavish production I hoped to find some inspiration as an antidote to the daily grind back home.

Rem Koolhaas was the curatorial ringmaster of this year's biennale. He established a three-part theme. In the rope factory was "Monditalia," an attempt to combine Italian dance, music, theater, and film with architecture. These subjects were spatially shuffled and graphically rich. But much of the subject matter was unfathomable. I had the impression of working my way through a giant Joseph Cornell box. Whereas it is fascinating to regard Cornell's mysteries from outside his sealed box-worlds, it is rather unsettling to actually be inside one.

"Absorbing Modernity" was the theme Koolhaas assigned to the 66 nations participating in this year's biennale. Many participants responded with an illustrated history of how modernism overswept their nation. All were interesting, but the deluge of material presented was more fitting for a series of history books than for the flow of a huge exhibition. Others attempted to solve this dilemma by editing so much that all we were left with was a few ideas in white space. By contrast, several countries threw out methodology altogether, resulting in exhibits resembling the aftermath of a studio charrette.

One must give Koolhaas credit for attempting to steer away from the traditional biennale format: each nation offering up its architectural stars' most spectacular stunts du jour. In so doing, however, he perhaps steered too far in the other direction. With no star performances this year, we were left primarily with displays of information. Despite the earnest efforts of at least



## Of Note

a thousand creative people from every part of the world, a hollow feeling prevailed.

I found myself filling the hollowness with bits of display design itself. In the American pavilion, the custom trestle table supports fabricated from steel tubes were admirable. In the Danish pavilion, delicate fiber optic fittings had a magic about them in concert with the ephemeral objects they lit. A deep velvety charcoal stain on MDF board was striking in the Arab Emirates display. White landscape contour models in the Canadian pavilion were enlivened with lines and motion by tiny digital projectors. Design incidents such as these were everywhere. But by far the most inspiring architecture and environmental design at the biennale arose from the ancient Arsenale buildings themselves, from the arcadian setting of the Giardini, and from the Nordic pavilion designed in 1962 by Sverre Fehn, one of the great modern buildings of the world.

The last curatorial component occupied the grand central pavilion of the Giardini. The exhibit presented Koolhaas' research into the following list of subjects he deems the "Elements of Architecture" — ceiling, wall, floor, facade, fireplace, corridor, balcony, toilet, ramp, stair, escalator, elevator, window, and door. This list struck me as peculiar for its inclusions and for its exclusions. And a paradoxical atmosphere pervaded the entire pavilion: On the one hand, the subject matter was inventively explored through vivid graphics and a fascinating array of actual architectural fragments. On the other hand, the investigations were tinged with a vague undercurrent of menace. It became apparent that, although Koolhaas did not display any of his own projects, we were basically walking through a three-dimensional mock-up of his design process: a preamble of supposedly neutral research calculated to yield an off-beat, hip architectural story line.

Fatigued by the time I reached the 'window' section, I noticed a beckoning doorway. It opened to a small courtyard enclosed by ivy-covered brick walls, with a lyrical shade structure, linear pools, and places to sit. Immediately upon entering this space I felt restored, the hollowness filled. Every one of the "Elements of Architecture" *missing* from this year's biennale was wordlessly celebrated in this small outdoor room: space, light, and form; structure, material, and craft; alliance with nature, human repose. And then it suddenly dawned on me: This courtyard was designed by the late, great Carlo Scarpa. I



*Water is the focal point of Carlo Scarpa's garden at the Fondazione Querini Stampalia in Venice.*

had seen it in books over the years, a minor work of his, but I never knew where it was.

One of this architect's masterworks is across town at the Fondazione Querini Stampalia, a 16th-century palazzo housing a library and art collection. Woven into the palazzo's ground floor is a gallery and garden designed by Scarpa in 1959. This modern space is profoundly Venetian in its embrace of water. Its design acknowledges and actually enjoys the *aqua alta*, the periods of high water that have troubled this city for a millennium. A fascinating composition of marble channels frames the floor plan of the gallery and garden, collects the high water, and slowly diverts it away. How nice that the current gallery show happened to be a collection of Scarpa's construction drawings for these spaces. Hand-drawn details at full scale showed every screw and deliberated dimension. Also on view was an exquisite little documentary film that captured an occasion of *aqua alta* inside the building. We watch water slowly sheet across

the marble floors, tight detail shots of water overcoming the surface tension of stone. In the shadowed silence of these spaces, one can sense something spiritual here. Like Venice itself, this chapel-like gallery is balanced between timelessness and oblivion.

Upstairs in the Querini library, I thought about how crucial inspiration is for architects. The world maddeningly resists what we strain to give it, and this wears us down. Fortunately, a little inspiration can redeem a lot of travail, whether that inspiration is found in a book on one's bedside table, or on a trip to Venice. I sat near an open window overlooking Scarpa's garden. There, I wrote this article, accompanied by the sound of a fountain below, a distant church bell or two, the old creaking wood floors of the library. It was one of the most pleasurable afternoons of my architectural life.

Max Levy, FAIA, is principal of Max Levy Architect in Dallas.



Field Constructs Design Competition (FCDC) seeks to foster cutting-edge innovation through works that actively engage with natural and cultural factors specific to Austin, Texas and its surrounding region. The competition will result in the realization of up to eight funded commissions, selected by a jury of leading figures in architecture, design, and art.

#### **ENTRIES DUE**

**1 April 2015**  
[fieldconstructs.org](http://fieldconstructs.org)

#### **JURORS**

**Benjamin Ball,**  
Ball-Nogues Studio,  
Los Angeles

**Eva Franch i Gilabert,**  
Storefront for Art and  
Architecture, New York

**John Grade,**  
Artist, Seattle

**Virginia San Fratello,**  
Rael San Fratello,  
Oakland

**Jason Sowell,**  
The University of Texas  
at Austin School of  
Architecture, Austin

**Ingrid Spencer,**  
Contributing Editor  
Architectural Record,  
Austin

**FIELD  
CONSTRUCTS**  
**DESIGN COMPETITION**



# MOVING GLASS WALL Systems



## DESIGN THAT MOVES

- These doors open and close with just the push of a finger
- Pocket doors available in Aluminum and Aluminum Clad Wood in three or four panel configurations
- Bi-Fold available in Aluminum three, four, five or six panel configurations
- Seamlessly integrate with the other Milgard windows and patio doors



©2014 Milgard Manufacturing, Inc.

Contact: **Curtis Davis**, *Milgard Texas Architectural Representative*

Phone: **214-300-5671** Email: [curtisdavis@milgard.com](mailto:curtisdavis@milgard.com) Web: [milgard.com/texasarchitect](http://milgard.com/texasarchitect)



2014 Most Used Vinyl Brand

**Builder** ///  
READERS CHOICE  
2013 Builders' Choice  
"Favorite Product"



*Clearly. the best.™*



## Sizing Up Design: Two Perspectives

Two Dallas-based architects discuss the role design plays in their everyday professional lives. Ron Stelmarski, AIA, design director for Perkins+Will, explains why a big firm is the best place for him, while Jessica Stewart Lendvay, explains that only a small practice can give her the freedom and flexibility she enjoys.

### Working Big

by Ron Stelmarski, AIA

I've worked in small boutique design shops before, and I can't imagine my career path without that experience. However, I can pinpoint the time when the big vs. small condition was put into very clear focus for me. A few years back, I was reading a design magazine when I noticed that I'd read four pages on the design of a 1,200-sf coffee shop. During this time, I was working on the Princess Nora University in Riyadh, Saudi Arabia (a brand-new, 30,000,000-sf university for women). The project was not big; it was enormous. Reflecting on the different scales of practice, I realized that even if the large size wasn't better, everything that a large-scale project brought with it, was. I've come to embrace the range, speed, complexity, and team-based aspects of working big. Below are the top 20 reasons I work at a global design firm.

1. The pulse. It is dynamic, fast-paced, and unexpected. You have to embrace complexity.
2. Scale-shift. On a daily basis, I engage the book, the building, and the city.
3. Making big good. Large projects are too important to the life of the city not to be great.
4. Civic work, the public realm, the fabric of cities. I like connecting these dots.
5. Constant collaboration. Like it or not.
6. Large projects = large teams = many different individuals = productive differences = great projects.
7. Technology happens.
8. Multidimensional teams. I work with architects, brand designers, urban designers, anthropologists, nurses, and many, many others.
9. Social advocacy. Perkins+Will commits one percent of our billable resources to pro bono initiatives. (This equates to a 15-person firm working full time all year.)
10. Cross-cultural engagement. I work with teams that include North American designers, Lebanese engineers, a Chinese rendering house, and Saudi Arabian builders.
11. Researching everything: health and wellness, performance, materials, technique, etc.

12. Global benchmarking. We live in a flat, global world — participate!
13. Design. I apply creative thinking to everything I do.
14. Small projects. Yes, they sometimes sneak into our office.
15. Craft. We craft materials, but we also craft public spaces.
16. Silos. I like to break them down.
17. Prioritizing design. I am constantly struggling to overcome misconceptions that design is not a top priority in large practices.
18. Frequent-flyer miles.
19. Cities. I believe in cities. My firm builds cities.
20. The people. Last, but never least, I appreciate the people and all the unique voices they bring to the process.

### Diary of a Small Firm

by Jessica Stewart Lendvay

I spent six years interning at a respected small firm, and then, after several unsuccessful ventures into alternate career paths, I started my own firm. I finally found a way to practice architecture that feels right to me. As architects, we are most useful when we collaborate with a visionary client and a skilled, thoughtful construction team to produce long-lasting and inspired places.

**Monday.** We worked all weekend on a SD deadline and issued the set last night. It feels like Friday, but it's time to look alive and start the week again. There's an important presentation at 1:30 p.m. today. Invoices also need to go out ASAP. Con-firm second babysitter to cover the late meeting. Verify all employees have plenty of work for the week. No time for lunch, and the meeting starts in 15 minutes. Stuff bag with snacks and head to the meeting. In the meeting, I enjoy the freedom of speaking authentically about our work. I feel helpful and important. While speaking frankly, I break character and embarrass myself. Those words echo in my head for the next 24 hours. The work was well received.

**Tuesday.** Work on invoices. I'm feeling a little empty after the big deadline. I need either gratuitous praise or a few hours of colorful unicorn

sketching to fill the void in my soul. Keep it together. A contractor calls while I'm stuttering, and there is an emergency to resolve. Thankfully, we develop strong working relationships with contractors. We encourage open communication in order to be included in the construction process. The employees are ready for more direction. Are we producing good enough work?

**Wednesday.** This is the deal-breaker day. If we don't make significant progress today, the week is over. Hustle. Get frantic. Freak people out. Try to calm down. Keep everyone busy at the office on two small deadlines due tomorrow while driving north on the toll road. Meet with trusting, visionary clients about a new project. We will have the opportunity to create a thoughtful design with this team. Feel lucky to be in my position, to facilitate this precious couple's vision. Receive an opportunity to visit an interesting project in 10 minutes. Rush home after site visit to take care of my son.

**Thursday.** Get text that my grandmother is sick. Head to the nursing home and sit with her until her doctor's appointment. Feel terrible that I don't spend more time with my family. Worry about meeting the commitments I made at the office. How do I lead my team to produce meaningful work and spend quality time with my family? Did I mention I'm having a baby in January?

**Friday.** Stave off deadlines, finish red-lines, send pricing set to contractor.

**Saturday.** It's quiet. I clean off my desk, and slowly little hopeful ideas appear. The light is nice today. I pull some favorite architecture books — "Luis Barragán: His House" and "The Houses of William Wurster." A few images provoke an idea to resolve a design challenge. Pull out trace paper and my favorite Pilot Razor Point pens and set out the direction for a new approach. Make lists and send emails to get work on track for next week.

**Sunday.** Finish invoices to send Monday morning. I retrace the steps of last week and sense there are some design opportunities not taken on a project. In repeating the moves we have made many times, I lay out the grid, confirm the view, the orientation, and the proportion, and find the aspects of our work that need development. I hope our response is inspiring and appropriate, sensitive to its context and purpose. ■





## LOOK AGAIN.

### ARTISAN MASONRY STONE VENEERS™ BY OLDCASTLE®

The premier full depth, structural veneer, that looks so natural you'll need to look twice.

[artisanveneers.com](http://artisanveneers.com)



#### Jewell Concrete Products

400 Jewell Drive  
Waco, TX 76712  
800-792-3216

©2013 Oldcastle. All Rights Reserved. ART13-0007



# CRAFT

Texas Society of Architects

**SAVE THE DATE**  
Fourth Annual Design Conference  
2015

**27 FEBRUARY – 1 MARCH**  
**DENTON**

[www.texasarchitects.org/descon](http://www.texasarchitects.org/descon)  
#DesCon2015

**SPONSORED BY**  
ACME Brick



Leading the new fencing generation

- > Blends nicely with any landscape
- > Durable
- > Easy to install
- > Extra strong with "V" braces
- > Secure & Aesthetic
- > 10 year warranty
- > Available in different heights

**Earth Friendly...**  
from start to finish



For more information visit us at:  
[designmasterfence.com](http://designmasterfence.com)

Call toll free:

**1 800 332 2376**

8 Colors Available:





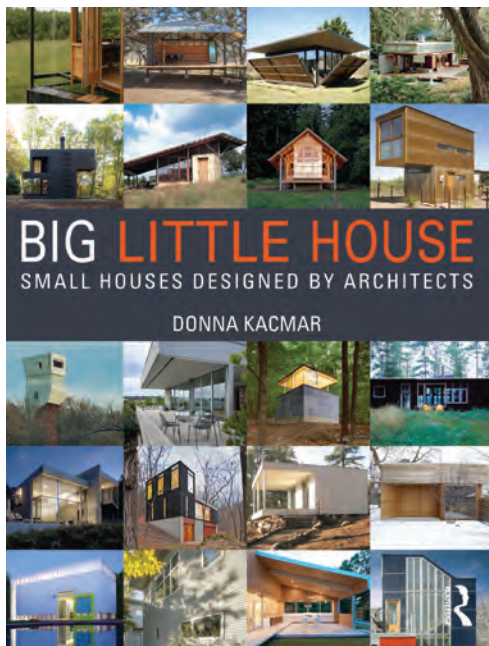

**BIG little house**

Donna Kacmar, FAIA  
Routledge (2015)

Houston architect Donna Kacmar, FAIA, has had a fascination with small houses since she designed her own house, its size a product of budget constraints that led not only to a small footprint, but also to experimentation with materials that Kacmar was not yet ready to unfurl on unsuspecting clients. In this laboratory of sorts, Kacmar’s engagement with small houses grew to become a significant portion of her professional practice and is now a well-researched, carefully curated, and thoughtfully organized book. In “BIG little house” (Routledge, 2015), Kacmar explores the architectural precedents of the current trend of small houses and expands her research into a catalog of 20 exceptional projects in the U.S. and Canada.

Organized thematically, the book presents an abundance of exemplars. At this scale, every gesture, detail, and design decision carries more weight and is thus rendered more immediate. Examining these exquisite buildings as if with a microscope enlarges our understanding of architecture and its essential role in our experience of the world. Some houses are writers’ retreats or libraries; others are primary dwellings. Some channel views toward celestial events; others provide privacy in a highly urban context. The feature they have in common is a footprint of less than 1,000 sf. Through interviews, Kacmar brings to light the architects’ perspective on the challenges and joys of designing small. The result is a book that is both encyclopedic and insightful — a portfolio rich with inspiration and ingenuity.

Canan Yetmen is an Austin-based writer.

**Plastic Stereotomy**

Justin Diles’ “Plastic Stereotomy” is the winner of TEX-FAB’s 2014 international digital design and fabrication competition. Asked to consider plasticity through the design of an architectural proposal that engages materiality, the possibility of form, experience, and performative consequence, Diles proposes redefining *poché* as a medium and connecting it to recent advances in surface design tools, digital fabrication methods, and materials engineering. “Thin-thick parts have geometries and connections to one another that might appear heavy or massive but are in reality light and thin,” argues Diles. “The idea is simple, but its implications are far-reaching.” Diles notes that developing these “thick-thin” parts or laminar *poché* realizes the possibilities for “new interactions between structure, construction, and expression, adding literal and discursive gravity back into questions of building and injecting volumetrically complex ideas for making and meaning into current discussions surrounding fabrication.”

A full-scale model of “Plastic Stereotomy” will be fabricated in collaboration with Kreysler & Associates and will be on display at TEX-FAB 2015 in Houston March 26–29. William Kreysler will speak at the event. ■



“Plastic Stereotomy” was on display at the Association for Computer-Aided Design in Architecture 2014 International Conference in Los Angeles last October.

BOOK COVER COURTESY ROUTLEDGE. RENDERING AND PHOTO OF PLASTIC STEREOTOMY COURTESY TEX-FAB.





Project "Double Negative," Goshute Canyon, Hoover Dam, Lake Mead, Nevada  
 Artist Michael Heizer  
 Photographers David Gregor and Chris Taylor

**Texas Architect**

**Texas Society of Architects**

**Coming Next Issue**

**March/April 2015**

**Features: Resiliency**

**Land Arts of the American West, Lubbock**  
 Chris Taylor

**Josey Pavilion, Denton**  
 Lake|Flato Architects

**Texas A&M University Digital Fabrication Labs, College Station**  
 Gabriel Esquivel

**Houston's High-Performance Curtain Walls**

- **BG Group Place**  
Pickard Chilton
- **Capitol Tower**  
Gensler
- **609 Main Street**  
Pickard Chilton

**Open House Feature**

**Monroe Street, Austin**  
 Finn Design Build

**Portfolio: Landscape**

**Houston Arboretum & Nature Center, Houston**  
 Design Workshop-Austin and Reed Hilderbrand

**Subscribe today!**  
[www.texasarchitects.org/subscribe](http://www.texasarchitects.org/subscribe)



# Architect.com/jobs

The most popular architecture job board in the USA

**30% job ad discount** for Texas-based employers using coupon code **TX-ARCH**



New Hampshire Institute of Art - Manchester, NH  
 Architect: Dennis Mires, PA, The Architects  
 Panel Contractor: A.W. Therrien Co.  
 Material: .032 aluminum PAC-CLAD Flat Sheet  
 Profile: SNAP-CLAD™ Panels and Flush Panels  
 Finish: PAC-CLAD Zinc Metallic



CASE STUDY

**LEED Gold Candidate**  
**AIA New Hampshire Excellence in Architecture Merit Award**

**PAC-CLAD® Panels and Flat Sheet in Zinc Metallic transformed the New Hampshire Institute of Art into a Masterpiece...**

"Metal is a contemporary material that allowed us to differentiate the form with the same material and finish, and yet create different textures: the varying width, vertical standing-seam form versus the metal shingles form. It also provided a hand-crafted character using an industrial material that seemed appropriate for an art college."

—Dennis Mires, PA, The Architects, Manchester, NH



**WWW.PAC-CLAD.COM | IL: 1 800 PAC CLAD**  
 MD: 1 800 344 1400 | TX: 1 800 441 8661  
 GA: 1 800 272 4482 | MN: 1 877 571 2025



See us at **METALCON!**  
 Booth 1517



Clockwise from top *The Charles Moore Foundation's Cube Loft at the Moore/Andersson Compound in Austin is a 9-by-9-ft white box.*



**Cube Loft**

Architects and design professionals have a new place to stay when traveling to Austin. The Charles Moore Foundation's Cube Loft at the Moore/Andersson Compound is a pristine space tucked into the otherworldly experience of the site. Located in the former homes and studio of Charles W. Moore, FAIA, and Arthur Andersson, FAIA, the Cube Loft is a renovation of an existing small studio with its own entry, originally located in the Andersson wing of the compound.

Designed by Kevin Keim, director of the Charles Moore Foundation, and Adam Word Gates, Assoc. AIA, the renovation transformed the original 81-sf room with a very tiny *en suite*

bath into an ambitious 220-sf space. Taking cues from an existing gable on the far side of the compound, Keim and Gates were able to expand up into the attic to insert a window and a sleeping nook. Steep stairs, inspired by original stairs in the compound, provide a sculptural element for the space while enhancing the feeling of getting away to a faraway place. Simple finishes and built-ins make it an ultra-efficient space. The Herbert Bayer prints are from the Keim Collection; the folk art is from the Shackelford/Caragonne Collection. "As designers, we imagined how this, the tiniest of rooms, had suddenly discovered it could claim formerly inaccessible space and finally satisfy its aspirations for a bit of spatial grandeur," says Keim.

**Calendar**

**FIELD CONSTRUCTS**

**DESIGN COMPETITION**

**Field Constructs Design Competition**

**Call for Entries**

January 2014

[www.fieldconstructs.org](http://www.fieldconstructs.org)

Field Constructs invites emerging designers, architects, landscape architects, and artists to submit proposals for a juried competition, which will result in funded temporary installations to be sited at Circle Acres Nature Preserve in Austin. Early-bird registration ends February 15.

**Arthur W. Andersson, FAIA**

February 4

[www.dallasarchitectureforum.org](http://www.dallasarchitectureforum.org)

Arthur W. Andersson, FAIA, will speak at the Magnolia Theatre in Dallas. Andersson and F. Christian Wise founded Andersson-Wise Architects in 2001, focused on the idea that a collaborative approach to design leads to a built solution attuned to its purpose, as well as on the broader issues of image and context.



**Fourth Annual Design Conference**

February 27

[www.texasarchitects.org](http://www.texasarchitects.org)

The Texas Society of Architects' 2015 Design Conference will focus on the craft of architecture with a particular emphasis on the work of O'Neil Ford, FAIA, located in Denton. Speakers include Tom Kundig, FAIA, of Olson Kundig Architects; Dr. Kathryn O'Rourke of Trinity University; and David Salmela, FAIA, of Salmela Architect.

PHOTOS BY KEVIN KEIM.



# Recognition

## AIA Dallas 2014 Design Awards

The AIA Dallas 2014 Built Design Awards feature a range of project typologies, from hospitals and schools to residences, playhouses, and park pavilions. Five projects were selected from more than 60 entries, based on each design's response to its context and community, program resolution, innovation, thoughtfulness, and technique. The jury included Coleman Coker of buildingstudio; Anne Fougeron, FAIA, of Fougerson Architecture; and Wendy Evans-Joseph, FAIA, of Studio Joseph.

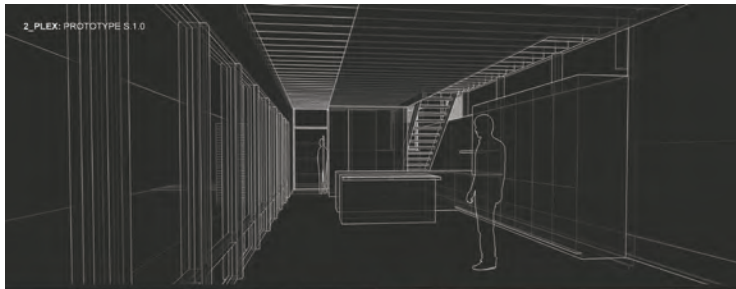

### Honor Awards

- 1 Oldrange Family Home**  
NIMMO
- 2 Satori Capital**  
Gensler
- 3 John Bunker Sands Wetland Center**  
Good Fulton & Farrell
- 4 Moncrief Cancer Institute**  
HKS
- 5 Zan Wesley Holmes Jr. Middle School**  
Perkins+Will

### Special Juror Commendation

- 6 2\_Plex**  
NIMMO ■





HANDCRAFTED  
IN AMERICA. 

*Ultimate Sliding French Door and Transom (1Z rated),  
Bronze Exterior AAMA 2605 finish,  
Rocky Mountain Solid Bronze door handle*

## SOME INVESTMENTS ARE MORE STUNNING THAN OTHERS.

*At Marvin, we take pride in the craftsmanship put into every window and door. We are committed to creating distinctive, beautiful products that continually elevate the standard of quality and innovation. Built on a foundation of values passed on through four generations, our windows and doors are an investment you will value for many years to come.*



SHOWCASING MARVIN WINDOWS AND DOORS

email: [marvininfo@BuildWithBMC.com](mailto:marvininfo@BuildWithBMC.com)  
800-888-3667 | [www.BuildWithBMC.com](http://www.BuildWithBMC.com)

**MARVIN**   
Windows and Doors

Built around you.®

See how Marvin can transform your home at [MARVIN.COM](http://MARVIN.COM)



# Paperwork

## Self-Sustaining House

Bercy Chen Studio

Self-Sustaining House's design optimizes a combination of rainwater retention and solar radiation collection methods, using a turbine-driven generator and compressor to satisfy all water and energy needs. It sits atop a fly ash concrete pedestal over a moat-like rainwater reservoir.

This cube-shaped structure maximizes the ratio of internal space to surface area. Inside, its two floors are joined by a spiral staircase embedded in its inner core: a trussed tower containing a water tank — a heat sink, as well as a 20-day supply of water.

Under the flat, glass roof, parabolic reflectors cradle copper pipes, preheating water that is then turned into steam with the aid

of another set of two-axis-tracking parabolic reflectors. The steam is then expanded through a turbine to power an electric generator and an air compressor. Batteries and a compressed air tank store energy output. Final expansion of steam is through an ejector to create flash vaporization for chilled water and nontoxic refrigeration. Steam is condensed and stored as hot distilled water.

With the help of soil-filled polypropylene socks, the cube's outer shell becomes a greenhouse garden of drip-irrigated hanging herbs that give food, shade, and oxygen. Rooms are ventilated in a top-down cycle, with fresh air flowing in at the top, traveling down the building's core, and exiting at ground level. Compressed-air-powered ceiling fans double as a sprinkler system in case of fire.

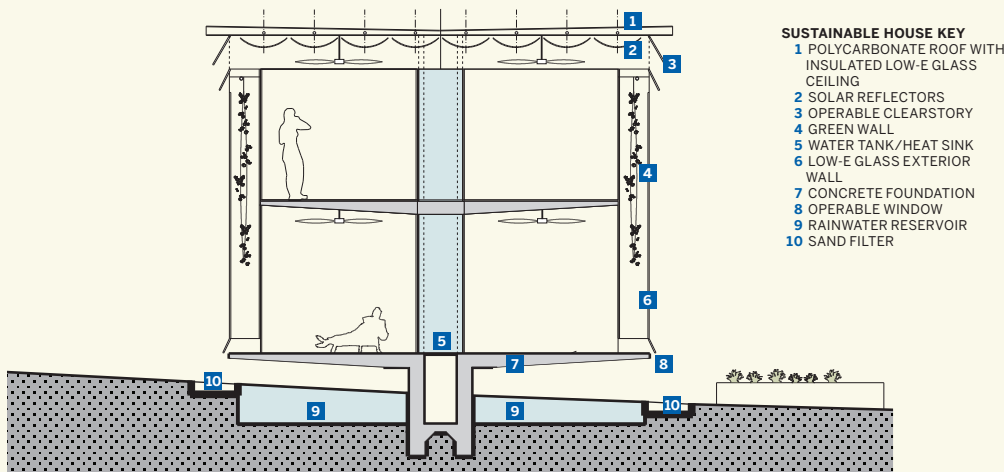
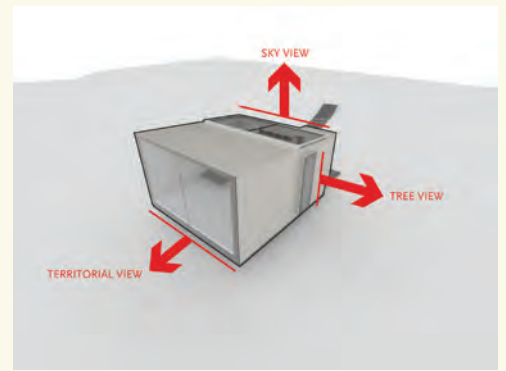

## Weather Room

LOJO (Logan and Johnson Architecture)

What if a writer's studio could be transported by helicopter to a series of inspirational locales? The Weather Room is such a place. Perched on a pedestal, with built-ins for books, a bed for naps and seating, and a writing desk that doubles as a couch, windows are this room's forte: windows anywhere the head can swivel; windows that reveal sky above, trees around, and whatever territorial panorama awaits, out the front wall of the small box.

This wall, a 15-by-10-ft plate glass window (whose proportions mimic that of a 3:2 film frame), is the Weather Room's undisputed "dash-board," reporting changing seasons, snow in the mountains, whitecaps out to sea, or waving wheat — according to where the room is planted.

Minimalist multitasking is the name of this design game. The Weather Room is built with inexpensive insulated structural panels and is easily assembled in a few days. A small truck (or helicopter) can move it from site to site. As auxiliary studio, not full-on living space, it has no need of plumbing or electrical hookups. It can come to rest in back garden, forest, or orchard; by field or by stream; on a cliff or on the shore. ■



studioOutside



Landscape Architecture and Urban Design  
214 954 7160  
[www.studiooutside.us](http://www.studiooutside.us)



Killy

[killyphotography.com](http://killyphotography.com)

*to learn more*



# Products

by Rita Catinella Orrell

Here, we present a few of the new sustainable products on display at last October's Greenbuild International Conference and Expo in New Orleans, including a ventless clothes dryer with a hybrid heat pump technology that might help reduce the billions of dollars in energy wasted annually by this appliance category.



## HybridCare Clothes Dryer

Whirlpool Corporation  
whirlpoolcorp.com

According to a recent Natural Resources Defense Council report, clothes dryers in U.S. homes waste up to \$4 billion in electricity annually because energy-saving standards for the appliance have not been significantly updated for almost 30 years. Instead of using large amounts of energy to vent hot, moist air — such as in typical drying systems — Whirlpool's new ventless HybridCare clothes dryer with Hybrid Heat Pump technology uses a refrigeration system to dry and recycle the same air. The ventless dryer also gives builders and designers the flexibility to place dryers anywhere in the home.



**Ultra A19 LED Lamps**  
Osram Sylvania  
osram-americas.com

These energy-efficient LED replacements for 40- and 60-watt incandescent lamps feature a unique light pipe for superior light distribution. Dimmable to 10 percent, the lamps can be used in both residential and commercial applications where an omnidirectional, dimmable light source is needed. The lamps provide up to an 85 percent energy savings, have a rated life of up to 25,000 hours at 70 percent lumen maintenance, and are available in a warm white 2,700K or bright white 5,000K color temperature.



## Reclaimed Wood Products

Pioneer Millworks  
pioneermillworks.com

Pioneer Millworks' FSC-certified, reclaimed wood products — including paneling, flooring, and timber framing — are manufactured in the U.S. from the company's New York and Portland, Oregon facilities. To date, they've rescued nearly 23 million board feet of old wood from rot and landfills. The company offers more than 50 species, grades, and specialty items that use natural finishes and retain the original patina, weathered gray color, original milling marks, and other signs of time. At Greenbuild, Pioneer premiered their newest line — exotic Teak salvaged from Indonesia that will be offered in a range of finishes. Shown here is reclaimed white barn siding installed in a New York City office project.





**Chiseled Texture + New Brick Sizes**

CalStar Products  
[calstarproducts.com](http://calstarproducts.com)

CalStar has several new brick products, including a split-face option and several unusual sizes. Like all CalStar bricks, the units incorporate 37 percent recycled content and eliminate the need for the kiln-firing typical of traditional clay brick. The chiseled-textured units emulate natural, cut limestone and are available in four heights — 4", 8", 12", and 16". The six new brick sizes include the Ambassador brick, a 2 1/4" high by 15 5/8" long unit that is available in smooth or split-face (shown) options.



**3300 MRL Elevator**

Schindler Elevator Corporation  
[us.schindler.com](http://us.schindler.com)

New to the North American market, the Schindler 3300 machine room-less (MRL) traction elevator is specifically designed for the low-rise commercial and multi-unit residential market. The gearless machine system is designed to save energy and avoid power loss. It fits seamlessly into the footprint of a hydraulic elevator design, yet provides the smooth, quiet operation of traction technology. In addition, Schindler 3300 cabs are up to five percent larger than the average MRL cab. The system is delivered to the building site in one complete shipment allowing accelerated lead times for building types including offices, churches, schools, condominiums, and apartments.



**Gyptone BIG Curve Panels**

CertainTeed  
[certainteed.com/ceilings](http://certainteed.com/ceilings)

According to CertainTeed, Gyptone BIG Curve is the industry's only perforated acoustical gypsum panel that can achieve highly curved ceilings without the cost and time associated with custom fabrication. BIG Curve seamlessly integrates with the company's other Gyptone products to create sweeping interior surfaces without any breaks or grid. At only 6.5 mm thick, the panels can be easily dry-bent to a 10' radius, and can achieve up to a 5' radius by wet bending. The low VOC-compliant panels are fitted with an acoustical backing tissue and are available in a variety of perforation patterns offering varying degrees of sound absorption. ■





## Your Master Source for Marvin Windows and Doors

For more information, please visit one of these BMC Window Centers.

### Austin

11212 Metric Blvd., Suite 300  
Austin 78758  
512-977-7440

### Corpus Christi

800-698-6618

### Dallas/Coppell

425 Airline Drive, Suite 200  
Coppell 75019  
972-304-1200 800-888-3667

### Fort Worth

4455 Camp Bowie Rd., #110  
Fort Worth 76107  
817-737-8877 800-955-9667

### Fredericksburg/Kerrville

603 FM 2093, Suite 1103  
Tivydale Business Park  
Fredericksburg 78624  
830-990-5717

### Houston

16002 Tomball Pkwy.  
Houston 77086  
281-440-9090 800-934-3502

### McAllen/Brownsville/Laredo

800-698-6618

### San Antonio

814 Arion Pkwy., #109  
San Antonio 78216  
210-494-8889 800-698-6618

### West Texas

800-888-3667

### Shreveport

800-888-3667



Built around you.™



2014 Design Award Winner  
Project Hog Pen Residence, Austin  
Architect Lake|Flato Architects  
Photographer Casey Dunn Photography

Texas Society of Architects

## 2015 Design Awards Call for Entries

The program recognizes projects by architects practicing in Texas to promote public interest in design excellence.

Entry Deadline 9 April 2015

[www.texasarchitects.org/designawards](http://www.texasarchitects.org/designawards)



COLLABORATIVE METAL WORKS



Cable Railing and Lumenrail®

Wagner Collaborative Metal Works  
info@mailwagner.com  
wagnercompanies.com  
(888) 243 6914

TxA Design Expo  
Houston, TX  
November 6-7, 2014  
Come visit us at booth #651





# CRAFT

**Texas**  
Society of  
**Architects**

**SAVE THE DATE**  
**Fourth Annual**  
**Design Conference**  
**2015**

**27 FEBRUARY – 1 MARCH**  
**DENTON**

Architecture tours and learning opportunities

**FEATURING**

Tom Kundig, FAIA  
Olson Kundig Architects  
Seattle, Washington

Dr. Kathryn O'Rourke  
Trinity University  
San Antonio, Texas

David Salmela, FAIA  
Salmela Architect  
Duluth, Minnesota

[www.texasarchitects.org/descon](http://www.texasarchitects.org/descon)  
#DesCon2015

**SPONSORED BY**  
ACME Brick



## Creek Show: Light Night

On November 13, the Waller Creek Conservancy's first annual Creek Show lit up nine blocks of downtown Austin. Despite the almost freezing temperatures, more than 1,000 people showed up to check out the installations and walk along the usually abandoned and derelict Waller Creek. As planning and development continue for Michael Van Valkenburgh Associates' linear park along the creek, Creek Show's "Light Night" provided a small glimpse of the potential for the creek to connect disparate areas of downtown as a community space. The installations both highlighted the ramifications of the diversion of the creek into a tunnel and celebrated the possibility of its future.

Architectural photographer Casey Dunn donated proceeds from the sale of large-format photos of Waller Creek, which were on display in the Waller Ballroom. The exhibition, organized and sponsored by Pentagram Austin, occurred two days prior to the "Light Night" celebration. "We wanted to get the community excited about the creek," said Ingrid Spencer, director of Creek Show, "and show Austin that their creek can be a clean, safe, beautiful place to gather."

### Hidden Measures

**Designer:** Jason Sowell, Associate Professor, The University of Texas at Austin

### High Water Mark

**Designer:** Thoughtbarn

### Light Bridge

**Designer:** Legge Lewis Legge

### Tracing the Line

**Designer:** Baldrige Architects

### Flow

**Designer:** Design Workshop ■



**Above** The construction of the flood diversion tunnel has transformed Waller Creek into an artificial "natural" system. High Water Mark manifests the invisible line of Waller Creek's 100-year flood plain.

**Left** Utilizing photoluminescent paint, Hidden Measures reveals the impact of the new diversion tunnel on the creek's hydrology and notes aspects of the creek's flood history.





**Clockwise from top** Symbolizing the chain of parks planned for Waller Creek, Light Bridge's single strands, made of speaker wire and segments of electroluminescent wire (EL wire), dangled in the wind. Tracing the Line was the largest of the five installations, a series of thin, illuminated tubes emerging from the center of the creek and stretching along nine city blocks. The draped-fabric panels of Flow were designed to capture and reveal wind patterns in the Waller Creek corridor while providing shade and shadows.



PHOTOS BY JAMIE LEASURE.  
PHOTO OF LIGHT BRIDGE COURTESY MURRAY LEGGE, FAIA.



**Jaclyn A. Tyler, AIA**  
Member Since 2007



---

## **Accelerate your career. Join us at the AIA.**

More than 83,000 members benefit from the tools and resources available only through the AIA. Join today for 2015 and get the rest of 2014 at no additional cost.

For details and to download a membership application, visit [www.aia.org/join](http://www.aia.org/join).

---

## **You could win a Surface Pro 3 or an iPad Air!\***

Join by December 31, 2014, and you'll be automatically entered to win a Surface Pro 3 or an iPad Air.

## **Join today. Then register—for free.**

New membership includes free registration\* to AIA Convention 2015.

\*Some restrictions apply. Review terms and conditions at [www.aia.org/join](http://www.aia.org/join)



**THE AMERICAN  
INSTITUTE  
OF ARCHITECTS**





*Blossom Street 03, designed by Nonya Grenader, FAIA, is an 850-sf studio and house built as part of a mother-and-daughter complex with a shared garden.*

## Why Small?

by Donna Kacmar, FAIA

Small-scale projects give architects an opportunity to focus on architecture’s most basic issues: enclosure, materials, light — and accommodating the act of dwelling. In larger buildings, the elegance of the design solution, its simplicity, order, and meticulous craftsmanship, can sometimes be hidden by various project complexities. On the other hand, when we visit or view buildings that are more limited in their size and scope, we can focus our attention on the execution of a few simple ideas.

Currently, a “reductive” lifestyle is being discussed relative to a “consumptive” lifestyle. Reducing the quantity of one’s possessions, the magnitude of one’s purchases — the size of one’s mortgage — can help simplify a complicated modern life. The so-called “small” and “tiny” house movements developed as do-it-

yourself trends in response to pressing environmental and financial concerns. The movement’s popular websites make the argument that, after 30 years of paying for mortgage financing, taxes, and

*Small dwellings are pared down, but they are not miniatures.*

maintenance, the real cost of a modest \$300,000 house mushrooms to over a million dollars and that the effort required to generate that sum might be redirected. Building only what is essential means financing, maintaining, and operating a minimalist version of home, helping inhabitants also reduce their environmental footprint.

The tiny house movement’s focus on compactness and efficiency is not new. Architects’ interest in modest dwellings brought on some

interesting experiments during the years pre- and post-World War II. Irving Gill’s modern constructions in southern California, Rudolph Schindler’s King’s Road House, Buckminster Fuller’s Dymaxion houses, and the California Case Study House programs were each models for low-cost houses developed within stringent parameters of size and materials.

Le Corbusier also designed and built a small house in 1952 in Cap Martin, France. The vacation house, a birthday present for his wife, was an experiment in proportion and prefab modularity. Built-ins organize the *Cabanon*’s tiny interior: its shelves, openings in the cuboid space dividers, light fixtures, batten joints in plywood cladding, clothes closet with arranged knobs, sliding panels — all are simple, useful, and artistic. Inward-opening shutters on the *Cabanon*’s windows are





**Above** Each interior space at Blossom Street 03 is defined by thick storage-cabinet walls. The living area feels spacious due to the high ceilings and light from multiple directions.

**Right and below** Grenader uses similar design strategies to maximize space in the study/guest alcove and bedroom areas.



accommodation. Building systems in small structures are often simplified or even eliminated, leaving only architectural elements and the exterior skin. The wall assembly, which regulates the small space's relationship to the external environment, determines how light is allowed to enter the space — the skin can be strategically thick or thin, porous or punctured. The wrapped volume of space might be compressed, elongated, or extended; it might be horizontal, vertical, or raised. Within the volume, the spaces can be fixed or flexible. Relationships between public and private activities can be static or changeable. Architects of smaller buildings can focus entirely on these essential architectural issues. Materials can also be more fully investigated in a smaller project. Specific material choices determine more than just the visual character of the building; Pallasmaa emphasizes that, in smaller projects, “the skin reads the texture, weight, density, and temperature of matter.”

And then there is the ever-important issue of light. Bringing light into a small space through the exterior walls and roof, from multiple directions, can seem to swell the room's dimensions. As in the case of Le Corbusier's *Cabanon*, by means of deliberate choices, spectacular vistas outdoors can become part of a small dwelling's indoor experience. Light-admitting strategies are simply easier to manage in a small structure with fewer openings. Inside, developing surfaces that absorb or reflect light in a variety of ways allows the architect to manipulate light as a material quality: It can be “soft, sharp, pellucid, crystalline” as argued by Charles Willard Moore, Gerald Allen, and Donlyn Lyndon in their book “The Place of Houses,” published in 1974.

Smaller projects are often fitted very specifically to the user and use, since each square foot really matters, and they can provide an opportunity to engage once again with only the most primary issues of architecture: enclosure, materials, light, and accommodating the act of dwelling on earth. The limited scope allows for more clarity to study the strength of the ideas expressed.

Donna Kacmar, FAIA, is a practicing architect and an associate professor at the University of Houston Gerald D. Hines College of Architecture. Her recent book, “BIG little houses,” is to be published by Routledge in March 2015.

lined with mirrors that reflect spectacular views of the landscape and sea beyond.

Small buildings can teach us how to dwell in the world. They may be simple. They can be, though they are not always, modest in cost. Small dwellings can be conservative in their use of energy and very particular in their positioning on a site. Small dwellings are pared down, but they are not miniatures. They must depend on good design choices for the enclosure; they rely on a studied sense of what to omit.

Finnish architect Juhani Pallasmaa notes that a simplified program or scope “allows a more involved architectural investigation” and can reveal an emphasis on efficiency in terms of materiality, light, enclosure, and





2014 Design Award Winner  
Project Hog Pen Residence, Austin  
Architect Lake|Flato Architects  
Photographer Casey Dunn Photography

## 2015 Design Awards Call for Entries

The program recognizes outstanding architectural and urban design projects by architects practicing in Texas to promote public interest in design excellence.

**Entry Deadline**  
9 April 2015

[www.texasarchitects.org/designawards](http://www.texasarchitects.org/designawards)





# Look Up to Fast Track Stone

The era of elegant stone in a lighter, leaner system has begun. Fast Track Stone™ masonry support system brings legendary Texas Quarries limestone and other quality natural stone and cast stone to a wide range of new applications. By supporting stone in a patent-pending system of channels, clips, and sealant, Fast Track Stone reduces veneer weight to as little as 14 pounds per square foot and eliminates the need for costly concrete footings.

The Fast Track Stone system promotes LEED achievement. Aluminum channels and clips have at least 25% post-consumer recycled content. The system can also be dismantled and repurposed when a building's use changes.

Use Fast Track Stone for new construction or retrofit, exterior or interior. Install our system over CMU, precast concrete, wood-stud, or metal-stud walls, using conventional techniques. Horizontal applications, including soffits, have never been easier nor more efficient.

Light, Lean, LEED-friendly  
Elegance and Flexibility

Kirkland Cancer Center  
Jackson, TN  
Davis-Stokes Collaborative, Brentwood, TN

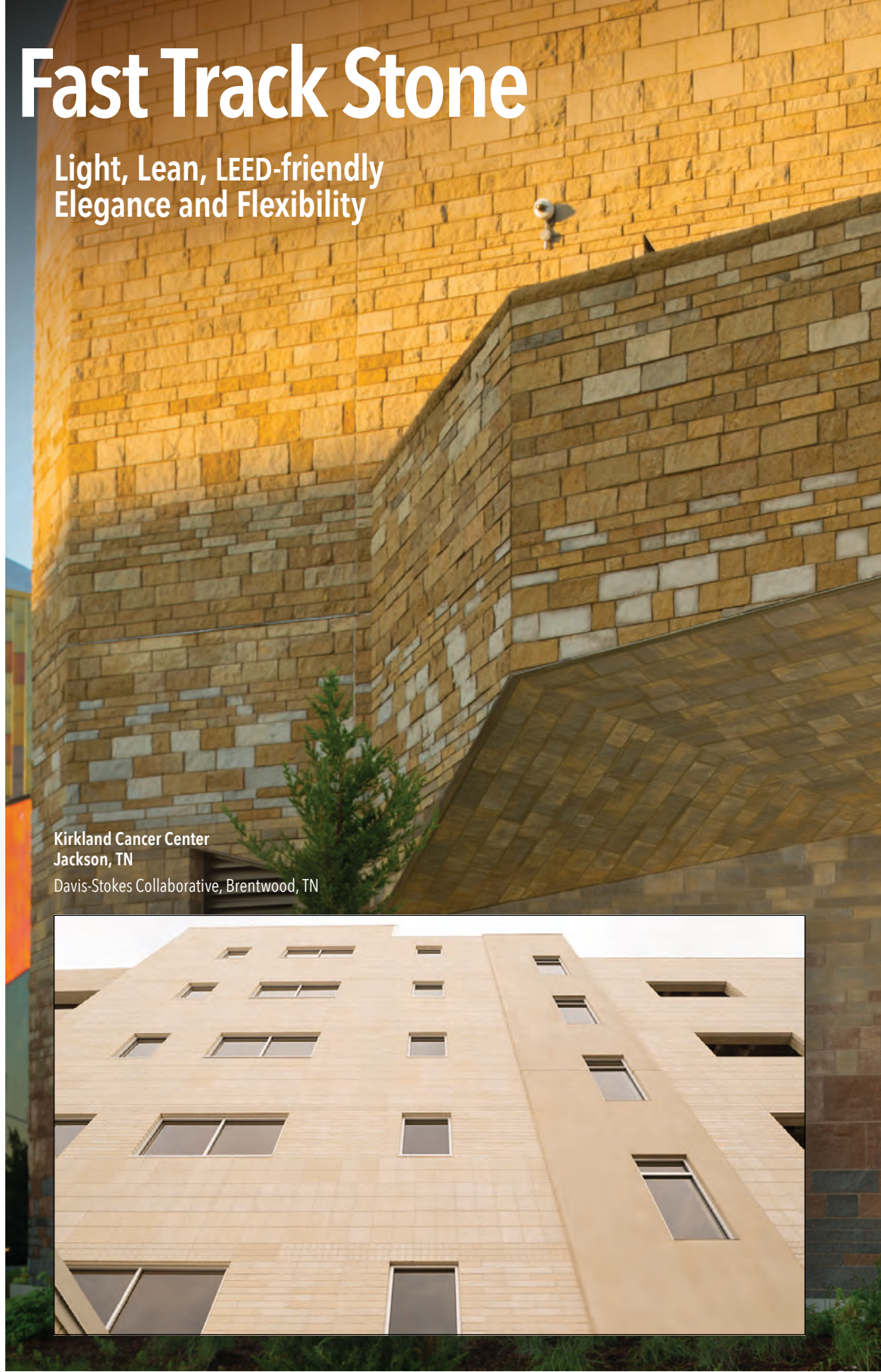
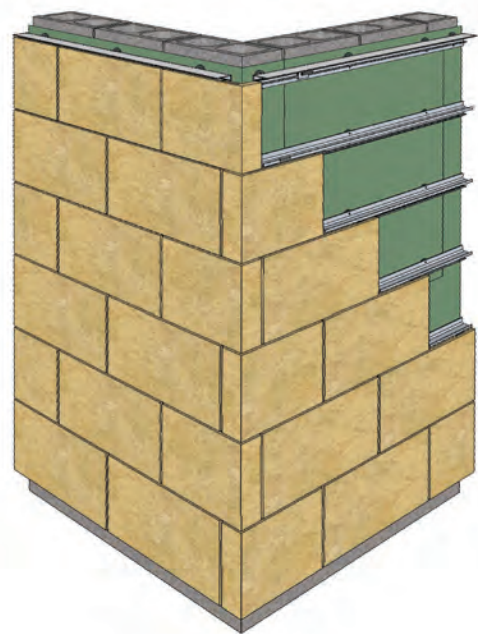

Fast Track Stone is perfect for Texas Quarries limestone and other quality stone products.

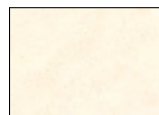

Cordova Cream



Cordova Shell

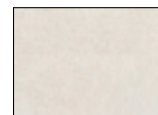

Lueders Buff

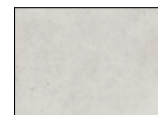

Lueders Gray



- Lightweight, Affordable Strength
- Reusable, 25% Recycled Content
- No Compromise on Quality

Tractor Supply Headquarters (soffit)  
 Brentwood, TN  
 Hastings Architecture Associates, Nashville, TN

Museum at Prairiefire (soffit)  
 Overland Park, KS  
 architect of record  
 Verner Johnson, Inc., Boston, MA  
 local architect  
 Rees Masionis Turley Architecture, Kansas City, MO



[fasttrackstone.com](http://fasttrackstone.com)



**From the earth,  
 for the earth.®**

For more details, drawings, and expert technical assistance, please contact your local Acme Brick representative.











# Guest Nest

by Jen Wong

**Project** Nested House, Houston

**Architect** LOJO (Logan and Johnson Architecture)

**Design Team** Matt Johnson, AIA; Jason Logan; Josh Robbins; Michael Viviano

**Photographer** Luis Ayala

The Nested House, a guesthouse built around a traditional sauna, supports full-range living and achieves spatial efficiency through thoughtful program placement. Though it was not designed as a small house, it could serve as a model for one. The 895-sf structure contains three essential spaces: sleeping area, combined living room/kitchen, and the central bathroom and sauna volume that separates the two. These programs are placed inside a simple drawn-out bar under a clean shed roof, the core pulled back to create a perimeter hall connecting the public/private spaces at either end. The kitchen extends outdoors an additional 600 sf, transforming the conditioned bar into a covered L with a partial gable roof and framing a space for a future pool. Look close, and you'll find details achievable only in projects of this scale — such as the subtle reveal that can be traced in one continuous, meandering loop around the entire interior.

Delivered from the talented minds of Jason Logan and Matthew Johnson, AIA, of LOJO (Logan and Johnson Architecture) to a backyard in



# Open House



**PLAN**

- 1 OUTDOOR KITCHEN/LIVING
- 2 LIVING ROOM
- 3 SAUNA
- 4 BATHROOM
- 5 BEDROOM
- 6 WARM POOL (FUTURE PHASE)
- 7 COOL POOL (FUTURE PHASE)

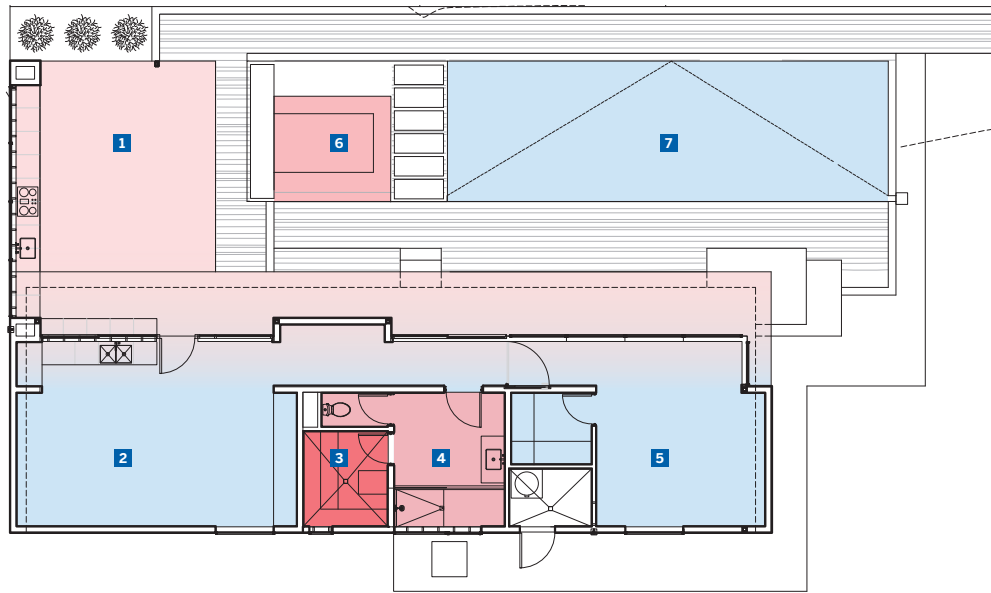

Houston, the Nested House is an accessory dwelling unit (ADU) that feels much larger. Copious amounts of northern daylight encourage this perception, as does the continuity between the interior and exterior.

Interlocking indoor/outdoor environments are thoroughly explored in the Nested House. An impressive 40 percent of the house is outdoor space, redefining the domestic routines and behaviors so prevalent today. “There’s a perception in Houston that you can’t live outdoors. Historically, you’ve seen the house here as a box that you pump air conditioning into,” said Johnson. “We’re trying to break the box apart.” This spatial restructuring, a strategy that can be seen in much of LOJO’s work, cut the percentage of

conditioned space dramatically. And the reduction lowered the overall cost of the project, but part of the challenge in designing smaller is the non-scalable relationship of price to square footage. No matter how small, a house still requires the higher-priced amenities of a bathroom, kitchen, and conditioning system.

“We don’t often get a client who is okay with the idea of doing such a small project, because it’s hard to explain why a really tiny project can still cost quite a bit,” said Logan. “I think there are a lot of people who are interested in building smaller and living smaller, but they have to get past the implications of what that means for cost.” One of the added cost







# Open House





**Previous spread** An abundance of natural daylight and a light material palette make the modestly-sized spaces appear spacious.

**Opposite page** The cove above the recessed north glazing houses exterior down lights and interior up lights, allowing for the ceiling to remain fixture free. Supply and return for the HVAC system is concealed in the building's felt-wrapped core.

**This page** Viewed from different angles, the roof profile alternately appears as gable, shed, or flat.



factors arose from the house's proximity to the Briar Branch floodway. In order to elevate the foundation the required 12-in above base flood elevation, the front and south facades sit atop a cantilevered, tapered slab, appearing to float on a delicate 4-in edge that doubles as a step up to the house from the outdoor kitchen. LOJO regularly converts such contextual cues into aesthetic high points by means of careful detailing.

Materiality is one of the clear drivers in LOJO's body of work: "People's responses to architecture are often about materiality, whether they know it or not," said Johnson. In this case, the clients' roots in Kazakhstan inspired key decisions: the wrapping of the central bath and sauna core in industrial felt panels, giving a nod to the traditional yurt, and the selection of resilient Siberian larch for the impeccably detailed rain screen. The execution of

*"There's a perception in Houston that you can't live outdoors."*

the rain screen is a particular point of pride for the architects, who were lucky

to land a carpenter who installed both the on-site millwork and exterior wood cladding. The second cladding material, standing-seam metal, was chosen in response to the climatic context. The reflective surface wraps both the roof and south elevation to reduce solar gain, a welcome intervention in Houston.

LOJO has been on a tear in recent months. The duo, who met while teaching adjacent studios at the University of Houston, was awarded an AIA Houston 2014 Award for the Nested House. "We hope that we can do more projects at this scale," said Logan. Added Johnson, "This project afforded us the opportunity to really focus on the basics, the simple idea of the building. I'm really excited about how this project fits into the trajectory of other work. It feels like we're defining something." Perhaps a part of that *something* is an earnest model for simplified living that maintains a high-end appeal.

Jen Wong is director and curator of the University Co-op Materials Lab at The University of Texas at Austin.





©2013 Oldcastle. All Rights Reserved. ART13-0007



**ARTISAN MASONRY STONE VENEERS™ BY OLDCASTLE®**

The premier full depth, structural veneer, that looks so natural you'll need to look twice. Experience modern innovation coupled with masonry's timeless beauty and durability. Full depth veneers deliver value to any project by combining energy efficiency and design freedom.

For more information, visit [artisanveneers.com](http://artisanveneers.com)



Jewell Concrete Products  
400 Jewell Drive  
Waco, TX 76712  
800-792-3216



# Tiny

Two getaways dwarfed by their surroundings, a collection of smart bus shelters, and a park pavilion round out the feature discussion on projects under 500 sf. A “limelight” butterfly sanctuary and a private school, built with fairy-tale fairs in mind, showcase how scaling things down leads to tiny takes on precise design.

PHOTO COURTESY URS PETER FLUECKIGER.

## 44

### Cabin Fever

Sustainable Cabin,  
Crowell  
*Urs Peter “Upe”  
Flueckiger, Texas Tech  
University College of  
Architecture  
Jack Murphy, Assoc. AIA*

## 50

### Big Ideas

VIA Bus Stop, San Antonio  
*Miró Rivera Architects  
MetroRapid Stations,  
Austin  
McKinney York Architects  
Uptown Station, Dallas  
Good Fulton & Farrell  
Christopher Ferguson,  
Assoc. AIA*

## 56

### Small Is Beautiful

Marfa 10 x 10 Lightbox,  
Marfa  
*Candid Rogers Studio  
Jack Murphy, Assoc. AIA*

## 62

### A Bench Is a Bench

Kidd Springs Park  
Pavilion, Dallas  
*Rhotenberry Wellen  
Architects  
Ryan Flener, Assoc. AIA*

## 66

### Bit by Bit

National Butterfly Center  
Welcome Pavilion, Mission  
*Studio Joseph  
Miriam Sitz*

## 72

### Keeping It Compact

The Girls' School of  
Austin, Austin  
*Haddon+Cowan  
Architects Collaborative  
Lawrence Connolly, AIA*









# Cabin Fever

by Jack Murphy, Assoc. AIA

**Project** Sustainable Cabin, Crowell

**Client** Pease River Foundation

**Architect** Urs Peter "Upe" Flueckiger, Texas Tech University College of Architecture

**Design Team** Urs Peter "Upe" Flueckiger; Benjamin K. Shacklette, AIA; Michael Martin; William Cannings; Carol Flueckiger; Derrick Tate

**Photographers** Urs Peter "Upe" Flueckiger and Denny Mingus

“I wanted to live deep and suck out all the marrow of life, to live so sturdily and Spartan-like,” wrote Henry David Thoreau after building his house at Walden in 1845. His back-to-basics impulse remains relevant today, even as technology revises, with each generation, the way Americans live (“meanly, like ants,” commented Thoreau). Thoreau’s experiment in minimal living is the inspiration for the Sustainable Cabin, a project by Texas Tech University (TTU) College of Architecture professor Urs Peter Flueckiger.

“Upe” Flueckiger began the project in 2007, using a fall sabbatical to raise money, set up matching grants, and develop initial concepts for the cabin. Le Corbusier’s *Cabanon*, a 12-by-12-ft prefabricated vacation home on the French Riviera he designed for himself, was also a principal influence. The Sustainable Cabin is also prefabricated and, at 12 by 24 ft, is nearly double the *Cabanon*’s size. Like Thoreau’s house, it uses recycled materials; built on half of a double-wide mobile home chassis, it makes use of the studs, axles, and wheels in the new construction. In an effort to avoid



NORTHWEST SECTION

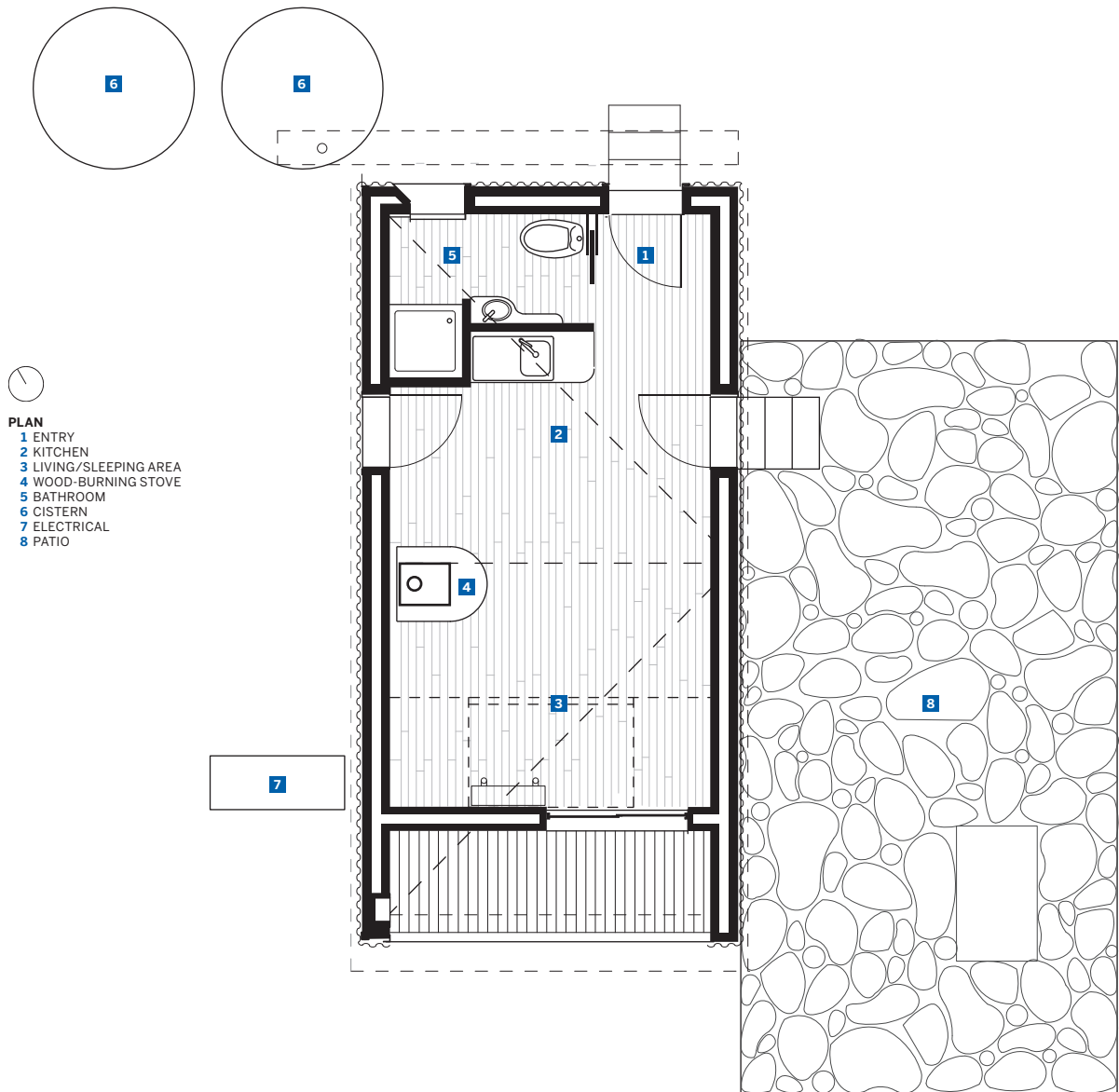
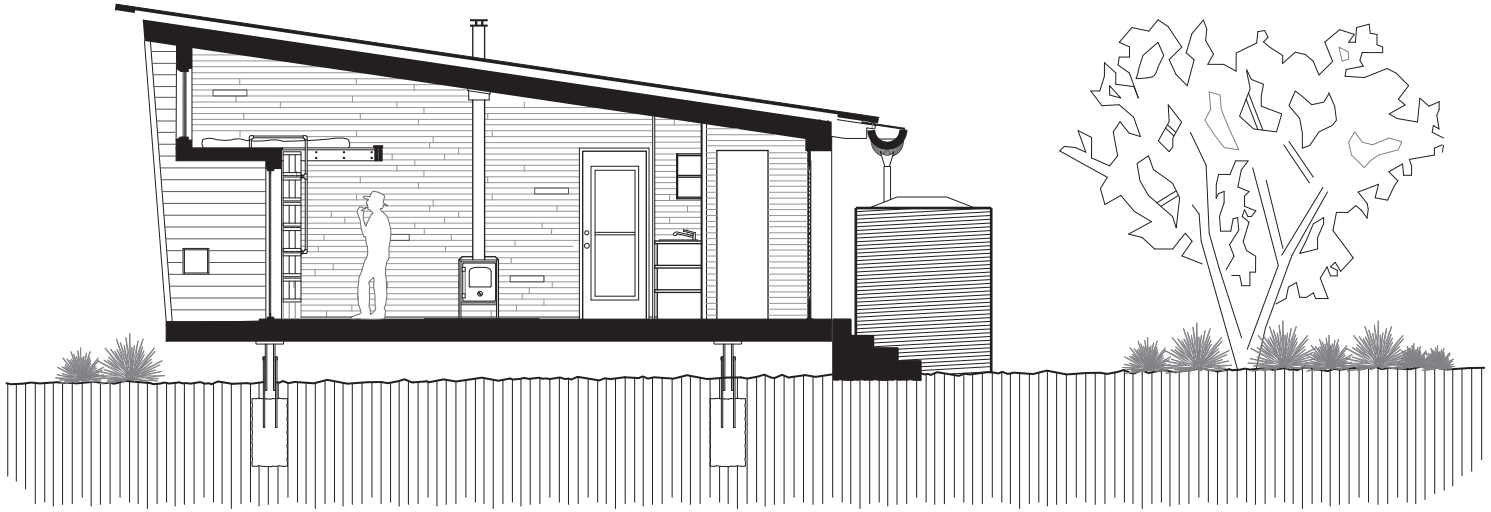

- PLAN**
- 1 ENTRY
  - 2 KITCHEN
  - 3 LIVING/SLEEPING AREA
  - 4 WOOD-BURNING STOVE
  - 5 BATHROOM
  - 6 CISTERN
  - 7 ELECTRICAL
  - 8 PATIO





**Opening spread** Urs Peter Flueckiger worked with his Texas Tech University College of Architecture students to design and build the Sustainable Cabin. The cabin was then towed and installed on property outside of Crowell, west of Wichita Falls.

**Left** The interior of the cabin is lined with yellow pine and features cedar stools designed by Flueckiger's students. The inset cyanotypes, by Carol Flueckiger, use sun-exposed ink to tattoo historic imagery onto integrated plywood panels.

**Below** The cabin was fabricated by graduate students using repurposed or donated materials. A major goal of the project was to introduce students to the practical difficulties of construction.



the cost of cutting-edge sustainable technologies, the cabin focuses on off-the-shelf solutions.

The cabin is 288 sf with a sleeping loft. Where it currently sits, the pitched roof opens to the southeast, with catchment basins fed by a gutter on the lower northwest edge. Vertical corrugated metal panels clad the exterior,

*“I wanted to live deep and suck out all the marrow of life, to live so sturdily and Spartan-like.”*

while the interior is yellow pine. Student-designed stools, made of 4-by-4-in cedar posts, are used both inside and outside. The ladder to the loft was fabricated using the school's CNC machines. Inset cyanotype wall pieces are the work of collaborating TTU art professor Carol Flueckiger, Upe's wife, and use imagery related to the Texas House, a residence built by Thoreau and his father on Texas Street in Concord, Mass.

Graduate students in architecture, mechanical engineering, and art worked on the cabin at a rented warehouse off campus. In three-hour class sessions over the course of two years, they rebuilt framed walls, cladded the exterior, fitted out the interior, and designed and built furniture. Licensed electricians and plumbers assisted with trades. Students developed the required systems (rainwater collection, waste treatment, a small solar array) to allow the cabin to exist off the grid, with the intention of testing the performance of the installed technologies.

**Once it was completed**, in the summer of 2010, the cabin was towed to its designated site outside of Crowell, west of Wichita Falls. The Pease River Foundation, an area nonprofit and a project donor, hosts the cabin on their property. TTU students visit and monitor the cabin, and Flueckiger reports that the cabin behaves as expected, holding temperature “remarkably well,” as it stays cool in the summer through nocturnal venting. Over the years,





the electricity supply has been sufficient, and the cabin has remained off the grid. No more than 70 percent of the available energy has been used on a daily basis — even throughout the night and on cloudy days. The only major repair required was the replacement of batteries for the back-up energy storage in the summer of 2014.

More recent work on site includes quarrying local stone to fashion a fire pit and patio; however, the foundation's distance from the school (150 miles) makes regular integrated classroom study difficult. Although studios have focused on additions to the camp, no concrete plans for expansion are in place. For now, it is a solitary outpost adrift in the West Texas landscape that Upe once described as “80 percent sky and 20 percent earth.”

Flueckiger's interest in economical, ecological housing informs his ongoing academic and professional endeavors. Beginning with his master's thesis and continuing throughout a 20-year career, Upe has focused on affordable prefabricated housing. In 2004, he and his wife built their own home for \$50 per square foot. The economic and environmental impact of the average American home — now up to 2,598 sf — makes it critical for us to revise the way we build and live. Thankfully, the “principles and ideas learned from the cabin are not confined to size,” Flueckiger notes. “Some of the cabin's concepts go, hopefully, beyond scale.”

Jack Murphy, Assoc. AIA, is a designer at Baldrige Architects in Austin.





**Opposite page** Once the cabin was in place, students quarried nearby stone, fashioning a patio and fire pit.

**Left** A bent wood stair leads to the south-facing sleeping loft. The cabin is heated by a wood stove but has no air conditioning.

**Below** Like Walden, the cabin is not accessible by road. No other structures are currently planned for the property. Thoreau's comment that "[o]ur horizon is never quite at our elbows" rings especially true in Texas.





# Big Ideas

by Christopher Ferguson, Assoc. AIA

**Project** VIA Bus Stop, San Antonio

**Client** VIA Metropolitan Transit

**Architect** Miró Rivera Architects

**Design Team** Juan Miró, FAIA; Miguel Rivera, FAIA; Sara Hadden; Michael Hsu, AIA; Matthew Sturich

**Photographer** Dror Baldinger, AIA

**Project** MetroRapid Stations, Austin

**Client** Capital Metropolitan Transportation Authority

**Architect** McKinney York Architects

**Design Team** Heather McKinney, FAIA; Al York, AIA; Brian Carlson, AIA; Alex Morris

**Photographer** Thomas McConnell

**Project** Uptown Station, Dallas

**Client** Cityplace Area Tax Increment Finance District

**Architect** Good Fulton & Farrell

**Design Team** R. Lawrence Good, FAIA; David M. Farrell, AIA; David Dumas, AIA; Todd Burtis, AIA; Joseph J. Patti, AIA

**Photographers** Nicholas McWhirter and Charles David Smith, AIA







About seven miles southeast of San Antonio, near the intersection of Interstate 37 and SE Military Drive — at the entrance to Brooks City Base — is an emblem of the history of flight. Designed by Austin-based Miró Rivera Architects, the VIA Metro Bus Stop is one of the first public elements to greet visitors and residents alike. It announces a mixed-use development that not only offers affordable housing options, but also boasts more than 400,000 sf of space slated for office, light industrial, and retail use. Less than 15 years ago, however, all 1,200 acres of this land belonged exclusively to Brooks Air Force Base, operating since 1917 consistently at the forefront of aeronautical development.

And the modestly scaled pavilion makes an immediate impression, its canopy of prefabricated nested steel tubes naturally swerving as if to spread its wings for lift-off. It is a gesture bold enough to celebrate the site's proud legacy in aviation while also giving a not-so-subtle nod to the importance of accessible public transit in the growing community. In short: This is not your ordinary bus stop. It is a fiercely intelligent landmark that publicizes design ideals at both small and urban scales.

“As an office, scale is not what drives us,” Juan Miró, FAIA, explains: “We approach these projects from a philosophical point of view. This was a design challenge, an exploration of honest structure and logical design. What you see is what you get.”

Indeed, the entire structure is composed of just two materials: steel and concrete. Its components were prefabricated and painted off site, allowing for an efficient installation that required few subcontractors. The roof elegantly returns rainwater to the ground through a narrow central core. The staggered, cast benches are visually playful but mainly serve to anchor the steel structural components to the foundation below. Hidden LED lights trace the profile of the benches at night, and the steel has been painted to resist graffiti.

“Small projects often embody bigger ideas,” says Miguel Rivera, FAIA. It's easy to see his point. The observation tower at Circuit of the Americas — the office's recently completed and internationally celebrated Formula One racetrack in Austin — seems to borrow its vocabulary of speed from the same structural ideas that give flight to the VIA Metro Bus Stop.





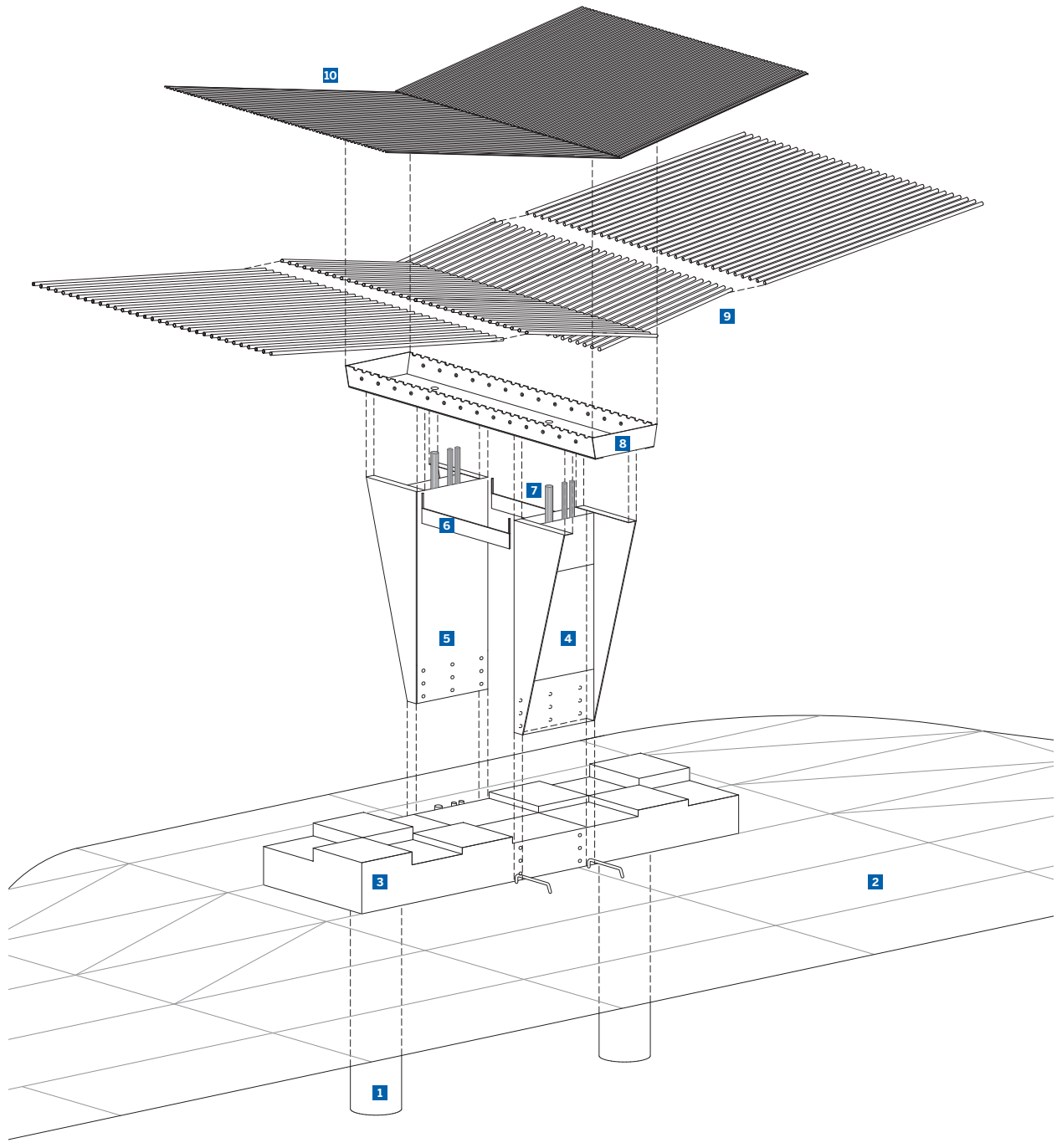

- VIA BUS STOP KEY**
- 1 PIER FOUNDATION
  - 2 SIDEWALK
  - 3 CONCRETE BENCH
  - 4 MAP
  - 5 VERTICAL SUPPORT
  - 6 PASSENGER INFORMATION
  - 7 GUTTER
  - 8 WATER COLLECTION
  - 9 SCISSOR-STEEL CANOPY
  - 10 CORRUGATED DECK SHEET





**Previous spread** *San Antonio's VIA Metro Bus Stop is a dynamic design that recalls the aeronautical history of the Brooks Air Force Base.*

**This page, clockwise from top** *Commuters view route information at the South Congress station of Austin's MetroRapid system. The design facilitates a nearly uninterrupted view beyond. Students await a MetroRapid bus near UT Austin's West Mall.*

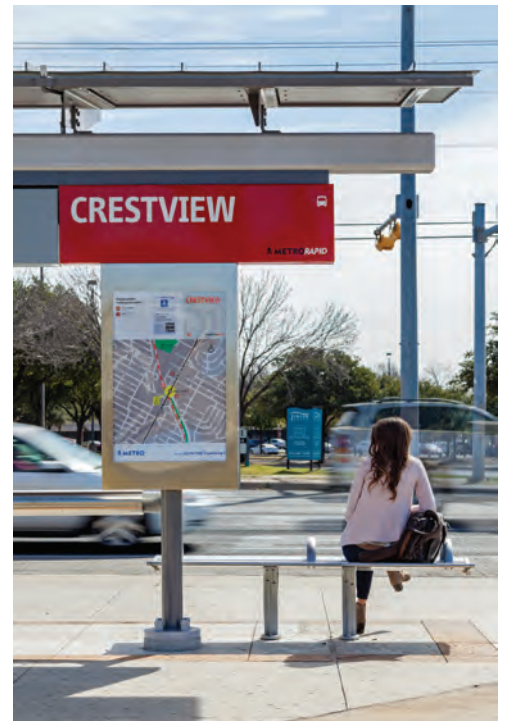





**AI York, AIA, of Austin-based McKinney York Architects,** is one to agree. His practice, which is currently overseeing the installation of 77 new Metro-Rapid bus stations through some of the most densely populated corridors in Austin, considers scale an afterthought to projects with cultural impact.

The new stations, with a sleek aesthetic and integrated technology, were specifically designed for Capital Metro's new line of MetroRapid buses. Promising fewer stops, free Wi-Fi, and even extra lighting and headroom, the initiative intends to improve the experience of commuting by bus in a city that increasingly depends on it. McKinney York's stations go a step further, however, and feature electronic displays that show real-time, GPS-based route information that even syncs with a mobile ticketing app on most smartphones.

"We can change the public perception of transportation in Austin," explains York. "It's about overcoming the perception that it's your option of last resort."

In developing the new stations, the firm was incredibly sensitive to place. York continues, "We had a lot of designs at first that felt unique, but above everything else it had to be 'Austin.' It needed to be relaxed but very smart, creative but unpretentious."

The clean lines and quiet poise of the final design suggest the office has hit the mark. For York, the success speaks to an emerging "Austin model"



**This page, clockwise from left** Dallas' Uptown Station is illuminated with LEDs at dusk. A rotating streetcar platform informs the radial awning design. "Synchronicity Light Receptors" by artist Margo Sawyer are installed around the station. Wood, steel, and glass components merge to form the station's canopy.

of transit, based on a variety of sophisticated public transit options including bikes, taxis, and various types of ride-sharing.

**In keeping with** the sense of place, Good Fulton & Farrell's emphatic Uptown Station in Dallas embraces the complexity of its context: the intersection of State Highway 75, the City Place Uptown DART Station, and the McKinney Avenue Trolley terminus. Its sweeping, radial awning of glass, wood, and steel is suspended from ten monolithic precast concrete towers organized around a functional, rotating streetcar platform. At night, the scene erupts in color as an army of integrated LEDs dazzles passersby in synchronous spectacle.

"We really wanted it to be an icon," says design principal David Farrell, AIA. "It's a merger of 19th-century rail technology with mass transit adjacent to a highway. It's about forward thinking."

Public infrastructure, when given the opportunity to navigate issues of efficiency, urban planning, aesthetics, and identity, can always transcend its scale. Projects such as these embody that potential, advancing a dialogue with the communities they serve through big ideas grounded in conscientious design.

Christopher Ferguson, Assoc. AIA, is a designer at Clickspring Design.







# Small Is Beautiful

by Jack Murphy, Assoc. AIA

**Project** Marfa 10 x 10 Lightbox, Marfa

**Architect** Candid Rogers Architect

**Design Team** Candid Rogers, AIA; Gonzalo Fraga; Ayuko Hishikawa

**Photographer** Chris Cooper





**Opening spread** *The dwelling, seen from the north, appears above the vegetation of Alamito Creek in West Texas.*

**Above** *Corrugated siding, run horizontally and vertically, has quickly weathered to form a rusty patina.*

**Left** *A metal canopy references area cattle grates.*

Upon arriving in Marfa from the east on Route 90, turn left at the Dollar General onto Spring Street and left again across Alamito Creek, onto Dallas Street. This will bring you to the Marfa 10 x 10 Lightbox, a minimal dwelling of 320 sf by San Antonio-based architect Candid Rogers, AIA.

This outpost is an exercise in restraint: Two 10-by-16-ft volumes, a 5:8 proportion, are stacked and offset by 8 ft, creating a double-height interior space and a cantilevered upper room. (For reference, the units of Donald Judd’s nearby concrete works are 1:2 in proportion, measuring about 8 ft, 2.5 in by 16 ft, 5 in, in plan, a clean 2.5-by-5 meters.) The 10 x 10 dwelling is framed conventionally, with 24-ft Microllam beams that run the length of the building to support the suspended second floor. Corrugated Corten steel siding — vertically oriented on the first floor and horizontally on the second — has oxidized, leaving a rusty patina.

The project won AIA Design Awards locally (San Antonio, 2007) and nationally (2008). The Lightbox, explains Rogers, was initially a

*Never make anything (politically as well) bigger than necessary.*

“destination of thought,” the altitudinal reward, if you will, of climbing more than 4,000 ft in elevation from the Texas coast into the Chihuahuan Desert. Inspiration came from tours at the Chinati Foundation and numerous walks in the town, on which Rogers noticed the ramshackle agrarian forms and the “utilitarian nature of the ranch structures with simple, single-material cladding[s] and smart orientation.”



EAST SECTION

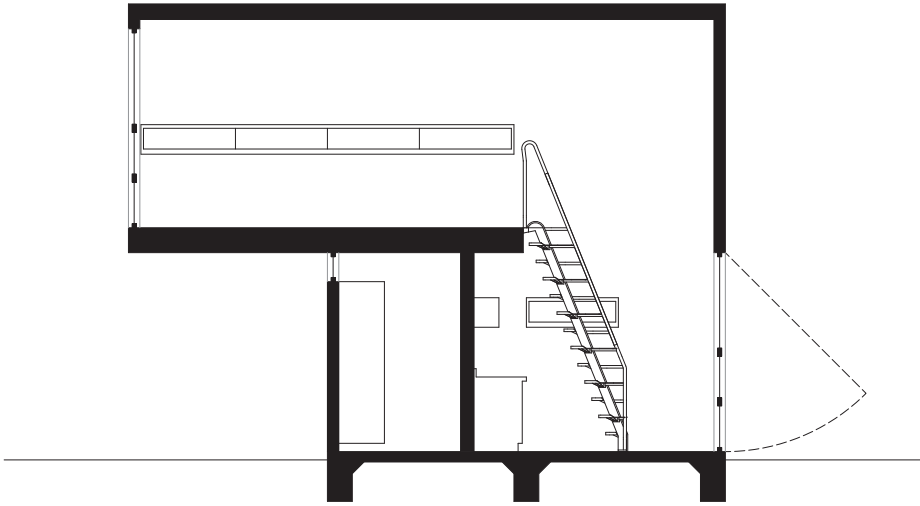

LOFT LEVEL  
1 BEDROOM

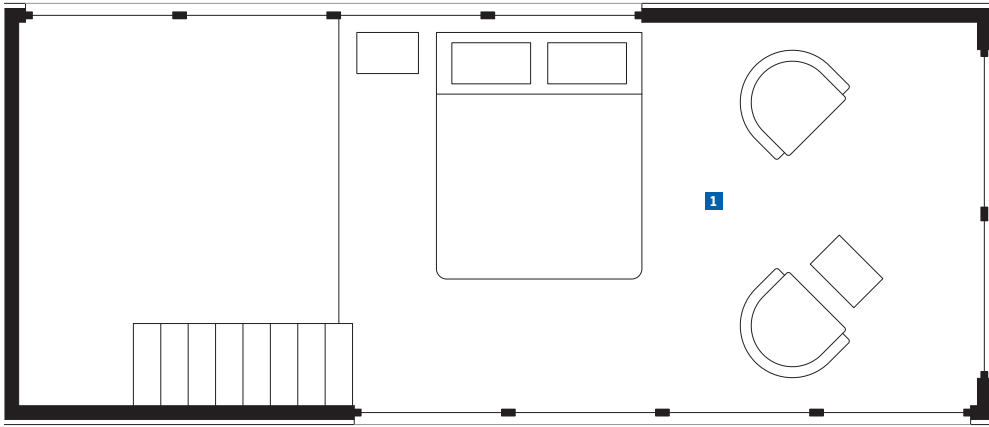

ENTRY LEVEL  
1 ENTRY  
2 LIVING AREA  
3 KITCHEN  
4 BATHROOM

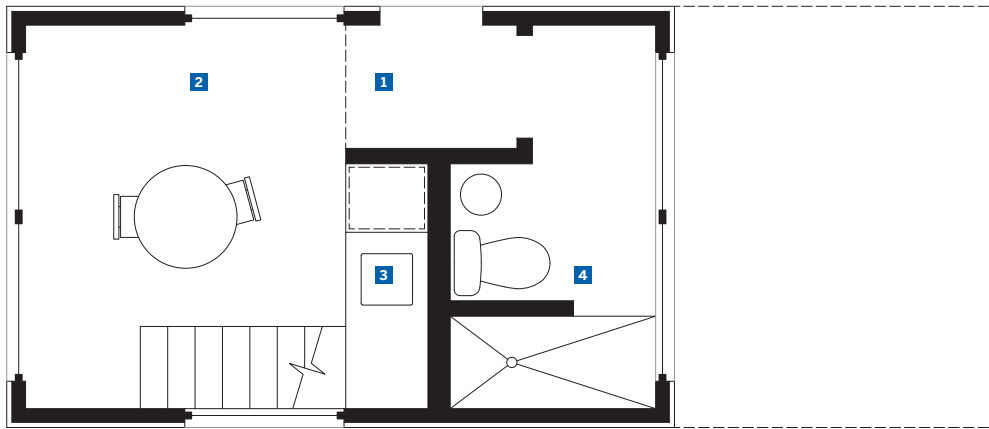



**This page, clockwise from top** A slender ribbon window looks out onto the horizon from the lofted sitting/sleeping area. The overhead canopy extends the living/dining space into the southern yard. This outdoor space is critical to experientially increasing the habitable size of the dwelling. A basic kitchen and bathroom occupy the first floor. An alternating-tread stair leads to the lofted bedroom.

**Opposite page** The plywood-floored bedroom is an elevated outpost of light, with a wallpaper of, in Candid's words, "cotton-like clouds that dot the sky." In such a small space, light and shadow become the main interior design elements.







The prominent upper-story window, measuring 10-by-10 ft, speaks to these two influences and can be seen from as far away as San Antonio Street (Route 90). The lower-floor windows are obscured for privacy. The cruciform division echoes the Suprematist window mullions favored by Judd in his renovations, but this reference was not preconceived: Rogers notes that originally the window had “a more abstract, asymmetrical pattern,” but temporary bracing during construction formed this cross, a reference that was noted, deemed appropriate, and preserved.

Since the lot is small, efficiency combined with a desire for elevated views dictated the design. A bathroom and small kitchen on the first floor open fully to a southern porch shaded by a steel-grate canopy. This indoor/outdoor arrangement expands the living area to an exterior patio that looks southeast across the plains. The upper bedroom loft, accessible via an alternating-tread stair, looks north through the main window to the Davis Mountains. Thin operable windows puncture the longer elevation, offering cropped glances of the endless landscape.

For Rogers and most others in the town, Marfa’s magic is in its sky. Though small, the house admits light from each of the four cardinal directions: through shaded southern openings, east and west sliders for cross-ventilation (reduced to limit solar gain), and a generous north-facing

aperture. Because the three rooms are small and furnished only with basic items, light, as it changes throughout the day and year, becomes the main interior decoration. Rogers poetically describes how, upon waking, “the richness of colored dawn’s light enters the linear, east-facing window at daybreak, as if it were the morning news on the nonexistent television set.”

The architect first designed the Lightbox for himself as a retreat for hosting students and friends, but it has since been sold to an owner who resides primarily in New York City. Such is the Marfa real estate market these days, it seems. “The tiny size of this project, I feel, goes beyond most people’s willingness to use it as a single, permanent residence,” notes Rogers. “I think this type of project is still an anomaly.” While Rogers does see downsizing trends, a cultural shift toward embracing “micro-housing” is still on the fringe of what the mainstream public is looking for in a home. The 10 x 10 Lightbox continues to inspire Rogers’ ideas today, which originate from his imperative to minimize spatial consumption while maximizing experiential aspects. Donald Judd felt similarly, penning a series of theses in 1987 that included a brief fifth directive, titled “Small Is Beautiful.” He wrote: “Never make anything (politically as well) bigger than necessary.”

Jack Murphy, Assoc. AIA, is a designer at Baldrige Architects in Austin.





# A Bench Is a Bench

by Ryan Flener, Assoc. AIA

**Project** Kidd Springs Park Pavilion, Dallas

**Client** Dallas Park and Recreation Department

**Architects** Rhotenberry Wellen Architects (Design Architect) and Shipley Architects (Architect of Record)

**Design Team** Mark T. Wellen, FAIA

**Photographer** Charles David Smith, AIA





*Truth and Honesty  
Can be two very different things  
The truth can be carelessly confessed  
And, honestly, the truth  
I do not ask and fear  
it's what I'll get*

— Blake Mills, “Heigh Ho” (2014)

**A**ll too often, our search for authenticity and honesty in architecture finds us misunderstanding these terms. It’s easy to overcomplicate, in our efforts to *rethink* what is “authentic” or “honest.” And, while these two sought-after qualities are important in building, they are rarely achieved. “It is what it is,” is a much more powerful statement than, “What is it?”

The Kidd Springs Park Pavilion by Mark Wellen, FAIA, of Midland-based Rhotenberry Wellen Architects is refreshing because it doesn’t try to be anything but a park pavilion. The project’s “it” factor

*His approach to the detailing through our shared pragmatic architectural lens demonstrated that he really understood what we were trying to achieve.*

lies in its modesty and politeness. Here, nothing has been rethought, over-specified, or misused. For Wellen, “The pavilion is a place to



pause from the walk around the lake, take a seat, and reflect on the surrounding environment.” It does little more, and nothing less, and because of its straightforward simplicity, Kidd Springs Park Pavilion is rather beautiful.

Completed in the fall of 2014 and located in Dallas’ Oak Cliff neighborhood, the pavilion was commissioned as part of “A Renaissance Plan,” a long-range strategic plan completed in 2002 by the City of Dallas Park and Recreation Department. This was immediately followed, in 2003, by a successful bond referendum that provided over \$100 million for park capital development, the largest single sum dedicated to such development in Dallas’ history. As part of this award-winning program, 23 new pavilions were commissioned to architects with records of excellence in design.

For Willis Winters, FAIA, Dallas Park and Recreation director, it was Rhotenberry Wellen’s reputation for good design — Winters is particularly fond of Wellen’s Cinco Camp project — as well as its hefty portfolio that inspired him to give the Kidd Springs Park Pavilion commission to the firm. Winters selected mutual friend and colleague Dan Shipley, FAIA, as the associate architect to manage the approval process and construction administration. “Dan’s execution of the design is exactly what I communicated to him in my sketches,” Wellen stated. “His approach to the detailing through our shared pragmatic architectural lens demonstrated that he really understood what we were trying to achieve. I’m truly thankful for having the opportunity to work with Dan.”

Kidd Springs Park Pavilion is nestled into the shallow knoll west of the lake, rooted to the earth by a cast-in-place concrete base that serves three functions: It is a retaining wall, a foundation for four steel columns, and a bench for passersby. Initially, the site chosen for the pavilion was further west in the park, but after spending some time at the site, Wellen and Shipley decided that it would be best to locate it along the pathway in order to take advantage of the view of the water and the gardens beyond. Six square concrete bollards, also suitable for sitting or standing on, transition the pathway surrounding the lake into the adjacent covered space of the pavilion.

The cable-stay roof, held up by steel posts, is made of galvanized steel bar-grate, which allows its open span to face the lake. In order to shade the seated area in the late morning and through the afternoon hours, solid corrugated metal decks are supported above the grated ceiling plane on steel purlins. Two steel channel flumes direct rainfall from the corrugated decks to the north and south corners of the pavilion.

“The budget for this was fairly modest, around \$150,000,” noted Wellen. “It made sense that the pavilion would explain itself — how it functions, how the roof is supported, and how water flows on and away from it. Most of all, it was fun. It was quick and simple, and I’m just grateful for being able to take part in the program.”

Wellen doesn’t promote a complicated architectural agenda. You can hear it in his voice, in his calm West-Texas drawl. You can see it in his work: Simple and clear projects like Kidd Springs Park Pavilion speak for themselves. The pavilion requires no instruction manual to use it, no white paper to understand its concepts, and little or no construction knowledge to understand how its systems work together to meet the basic needs of a park shelter. In its execution, it is undoubtedly honest, and through its expression of basic architectural principles, considerably authentic.

Ryan Flener, Assoc. AIA, is an intern architect at Good Fulton & Farrell in Dallas.

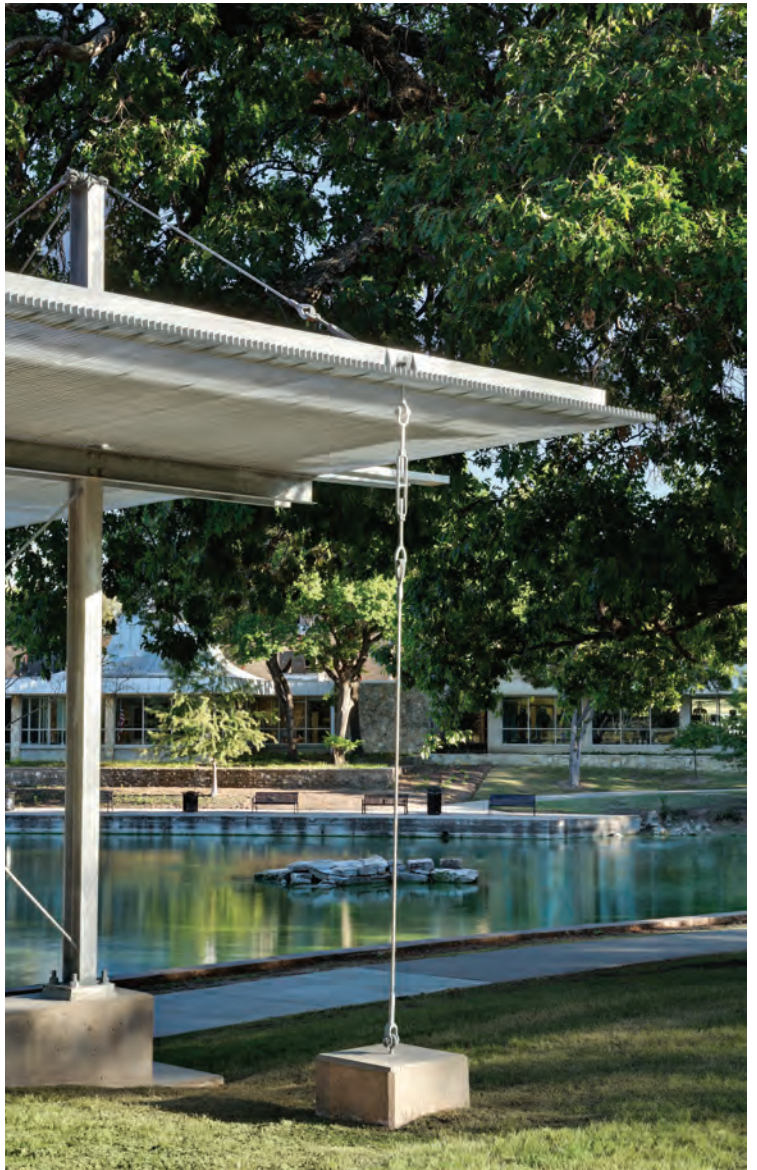



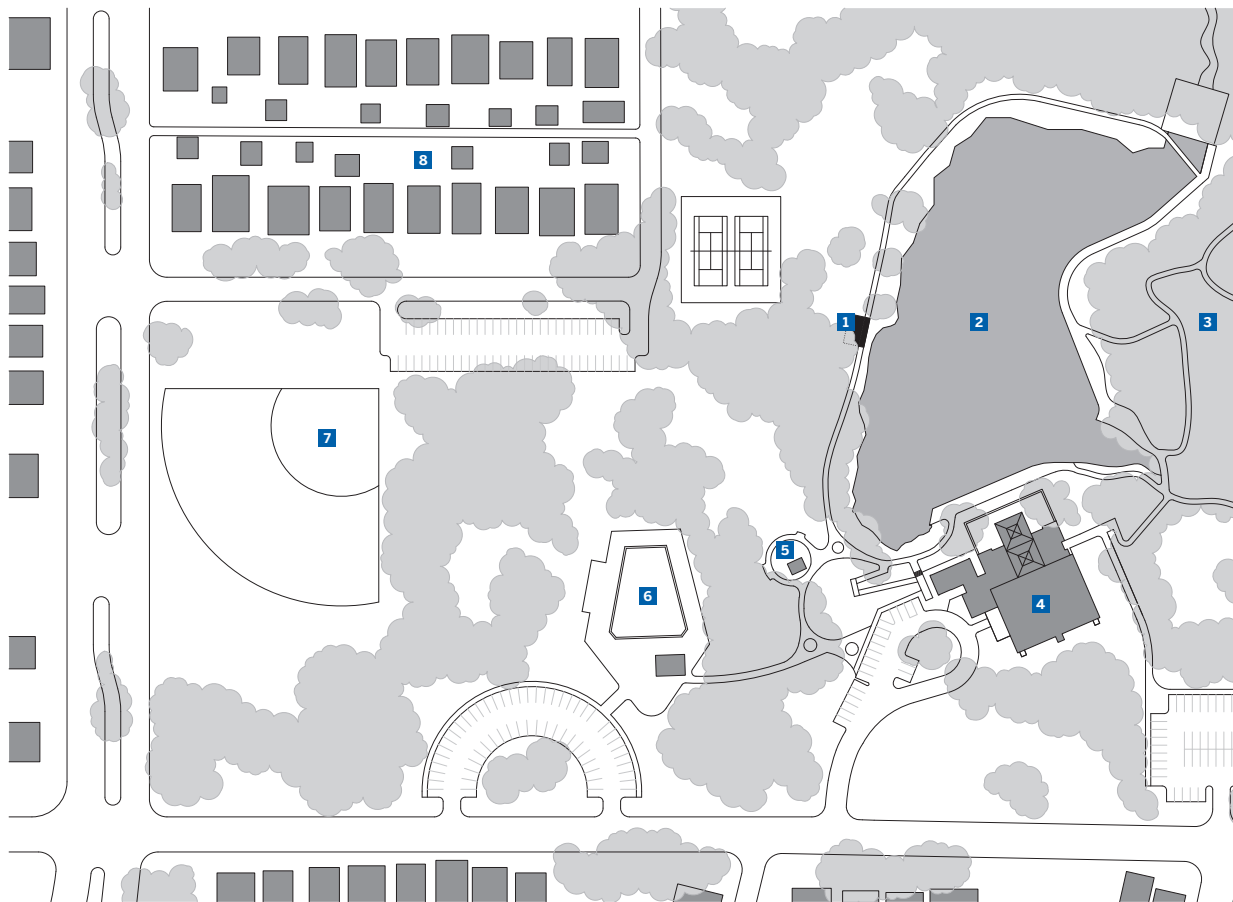

- KIDD SPRINGS PARK PAVILION**
- 1 PAVILION
  - 2 LAKE
  - 3 BUTTERFLY GARDEN
  - 4 KIDD SPRINGS RECREATION CENTER
  - 5 PLAYGROUND
  - 6 POOL
  - 7 BASEBALL FIELD
  - 8 SINGLE-FAMILY HOUSES



**Opening spread** *The Kidd Springs Park Pavilion is part of the Design Excellence program established by the Dallas Park and Recreation Department.*

**Opposite page** *The cable-stay, galvanized bar-grate steel canopy allows for the cantilever on the lake side of the pavilion. At night, light bounces softly from the canopy of the pavilion to illuminate the nearby area.*

**Left** *The design provides ample seating from the perimeter benches. The cubes serve as a demarcation from the adjacent sidewalk as well as convenient seating for games of checkers or chess.*



# Bit by Bit

by Miriam Sitz

**Project** National Butterfly Center Welcome Pavilion, Mission

**Client** North American Butterfly Association

**Architect** Studio Joseph

**Design Team** Wendy Evans Joseph, FAIA; Chris Cooper, AIA; Chris Good

**Photographer** Nathaniel Lieberman

To tackle what has become an almost 15-year master plan for the National Butterfly Center in the Lower Rio Grande Valley, Wendy Evans Joseph, FAIA, started off by dividing the 100-acre site into 22-sf parcels. This inclination toward modular design has informed everything about the site. “It’s almost a mini-Jeffersonian plan,” said Joseph, “except instead of six miles it’s 22 ft.” The pixelized landscape, she explained, has enabled the North American Butterfly Association to “conquer the site over time in bite-sized pieces as they raise money.”

New York-based Joseph began working with Jeffrey Glassberg, founder of the Association, on the organization’s South Texas headquarters in 2002. Located in the city of Mission, the Welcome Pavilion was designed

*There are no hills, and we didn’t want to take the focus away from the land.*

to play up local materials while also creating a striking contrast with the grounds. Dallas-based Studio Outside Landscape Architecture built on Joseph’s 22-sf grid to develop a comprehensive landscape for the site, and the capital campaign for the second phase of the grounds is set to start in January 2015.











Located along the Rio Grande River, the grounds include 30 acres of buildable land and 70 acres of Texas savannah, which will be left in its native state. According to Jane Scott, the secretary-treasurer of the Association, the organization opted for small, low-impact buildings on the flat landscape. “There are no hills, and we didn’t want to take the focus away from the land,” she said.

“Everything was designed to be simply assembled and readily available,” Joseph explained. “We tried to create a building that was of a more residential scale, so using local materials was part of the concept.”

The 4,400-sf Welcome Pavilion opened in October 2010 and has set the material palate and aesthetic vibe for the project. “Since it’s the first building,” said Joseph, “the idea was to make it as multipurpose and flexible as possible, while providing private and public spaces,” including an office, a café, bathrooms, a conference room, a gift shop, and an open area for exhibit and meeting space.

Designing the building more on the scale of a house than a commercial structure allowed for the use of local crews accustomed to residential construction — a budget-friendly move that expedited the process. “We hired a local general contractor who could manage this with his own small team and crew,” said Joseph. Building costs ran just \$130 per square foot, with a budget of \$750,000 for the building and an additional \$250,000 for site

work and parking. A 4-by-16-in cement block, imported from just across the border in Mexico and finished bright white thanks to the marble dust from a nearby quarry, covers the pavilion’s exterior. Aligning the blocks

*“Our goal is to maintain or reconstruct native plant habitats and provide for the butterflies,” Scott said. “But we also want to educate visitors about wildlife, and for that you need buildings.”*

vertically, “we pushed and pulled it from the surface,” explained Joseph, “to give texture, scale, and shadow in the strong sun.”

Other design elements respond to the harsh South Texas environment, as well. The white roof’s high albedo helps to cool the facility, and a recessed cornice of galvanized aluminum sparkles in the sun. There are no windows on the south side of the building, and the configuration of doors and halls allows for easy passive cooling.

Exterior landscape walls define areas outside the building, where a series of planted trees provides shade. Studio Outside designed butterfly-watching gardens in contained and open areas around the pavilion, bridging the transition between man-made and natural.





**Opening spread** An undulating modular desk system in bright white contrasts with the interior's immersive "limelight" color. Ceiling joists are rotated 90 degrees from one another, creating a sculptural checkerboard pattern.

**Opposite page** White-block paving and gravel surround the building. Double doors bookend the central hall, allowing for passive cooling when open.

**Above** A retention pond forms part of the storm water management system.

**Right** Arranged vertically in a staggered bond, some of the 4-by-16-in bricks are recessed slightly from the surface, giving texture to the exterior wall.







**SITE PLAN**

**PHASE 1**

**FUTURE**

- 1 WELCOME CENTER
- 2 EXHIBITION A
- 3 LIBRARY/OFFICE
- 4 EXHIBITION B
- 5 CONFERENCE CENTER/CAFÉ
- 6 MAINTENANCE AND ADMINISTRATION
- 7 GREENHOUSE
- 8 BUTTERFLY GARDENS
- 9 PARKING

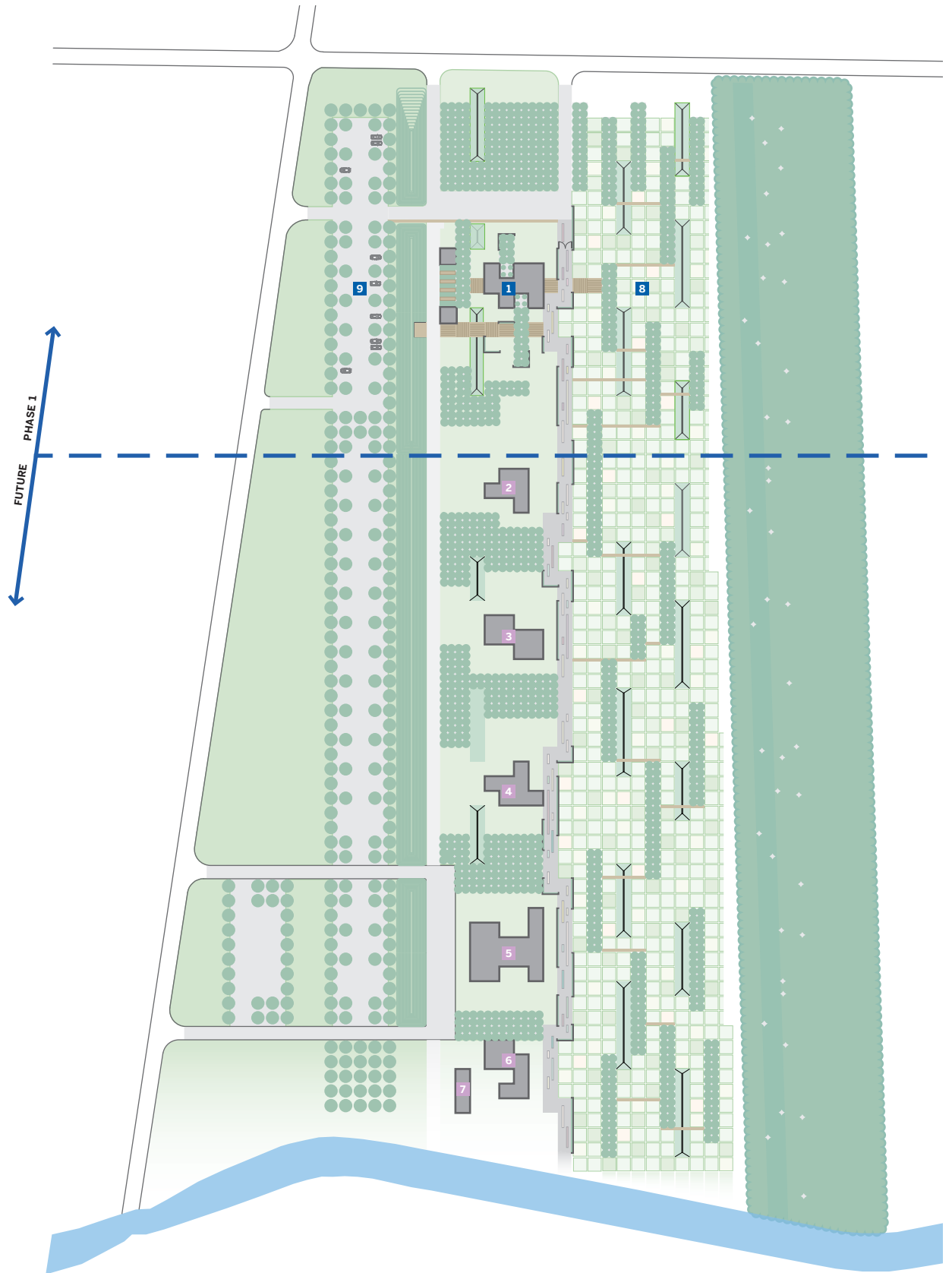





*A pathway of crushed local stone runs just outside the floor-to-ceiling windows of the conference room.*

Inside, the 12-ft timber ceilings feature 12-in joists, “which gives a look and patina we liked,” said Joseph. “We rotated the joists in every module, one against another, so you get an interplay, a checkerboard pattern.” With an easy-to-clean interior of simple concrete floors and polycarbonate walls, “they can pretty much hose down the place,” explained Joseph. “It can be very dusty and dirty in South Texas.”

In colorful contrast to the dry landscape, every indoor surface is painted bright yellow-green. “It’s called ‘limelight,’” said Joseph, “and in different lighting conditions it can look very green or very yellow, but it always seems to make the landscape outside look a little better.”

Harkening back to the bright white brick of the building’s exterior, all furniture inside is white. A curving, modular system of clear-plastic-

topped desks is fabricated locally and each is five ft long. “You can fit the pieces together to make any kind of a curve you want,” said Scott. “They’re attractive as well as incredibly useful” for retail and exhibition display, and for use during events.

Sticking to Joseph’s 22-sf grid “offers a very flexible base,” said Scott. Future projects may include a series of outbuildings — from a separate exhibit hall and a library space to an educational building — connected by a winding garden pathway. “Our goal is to maintain or reconstruct native plant habitats and provide for the butterflies,” Scott said. “But we also want to educate visitors about wildlife, and for that you need buildings.”

Miriam Sitz is a student at the Columbia University Graduate School of Journalism.







# Keeping It Compact

by Lawrence Connolly, AIA

**Project** The Girls' School of Austin, Austin

**Client** The Girls' School of Austin

**Architect** Haddon+Cowan Architects Collaborative

**Design Team** Michael D. Cowan, AIA; Mike Haddon, AIA; Jeff Garnett; Sam Gelfand; Catherine French; Katy Waeltz

**Photographer** Bronson Dorsey Photography

A bamboo-like forest and room for fairies were two very specific requests that the elementary and middle school girls at The Girls' School of Austin (GSA) asked of their architects, and with some imagination, Haddon+Cowan Architects Collaborative made both happen. Their work to transform the existing campus has aligned the school's mission with its physical space, maximizing the 1.8-acre site to create an integrated network of indoor and outdoor classrooms and activity areas. Shaded work and play areas protected by broad overhangs supported by skinny *pilots* purposefully reminiscent of a forest, a stepped bioswale with ample gardens, and a new fairy field are all essential to the everyday education of the students.

GSA opened in 2002, with five students in the fifth and sixth grades, as the first all-girl school in the city. Back then, there were more teachers than students, and the campus was a tiny house west of downtown. Despite this (or maybe because of it), GSA developed a creative pedagogical





model of “place-based” learning that makes use of the natural, social, political, and artistic opportunities in Austin and its surroundings. In 2003, the school moved to the decommissioned Austin Independent School District Dill Elementary campus in the middle of the Tarrytown neighborhood in west Austin. The building was 60 years old, but its non-institutional, mid-century modern design fit the site at a human scale. Light flooded into the classrooms from window walls on two sides;

*The overwhelming response was that they liked being outside, and they liked that the school was small.*

however, the program was based on a traditional educational model that kept most activities indoors. The challenge of realizing the school’s mission, coupled with the increasing size of the student body, prompted the administration to pursue building a new facility that would support and facilitate the place-based curriculum without losing the considerable charm and assets of the predecessor.

When the GSA Board hired Haddon+Cowan, building on what was right about the school took priority, and feedback was gathered from the entire school community. “We met with students in each grade to talk about the new campus and ask them directly what they liked best about the school, and





**Opening spread** A privately-funded replacement of a mid-century public school, *The Girls' School of Austin* by Haddon+Cowan Architects Collaborative maximizes its small footprint while maintaining a sense of the original building's small scale.

**This spread** Age groups correspond to building levels, with elementary on the lower floors and middle school on the upper floors. Natural wood ceilings and corrugated-metal cladding provide warmth and charm. Outdoor education and playtime are essential to the curriculum. All areas of the site — including the garden in the central bioswale, the open-air corridors, and the rooftop gardens — are pressed into service as learning aids.





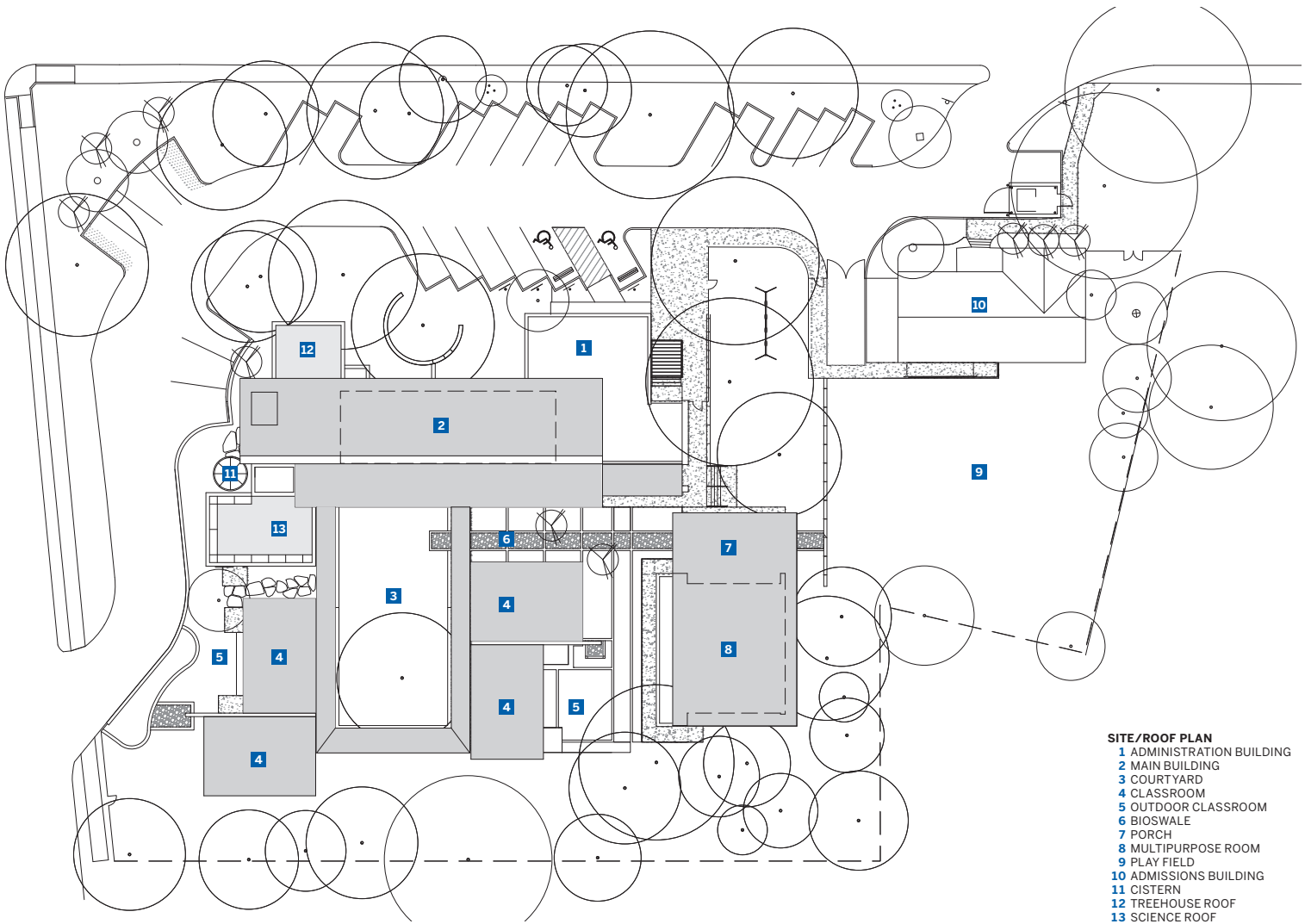





*Seating areas throughout the campus have proven to be much loved and used.*

what they wished for in a new school,” said Michael Cowan, AIA, principal of Haddon+Cowan. “The overwhelming response was that they liked being outside, and they liked that the school was small.”

Nature is a big part of the GSA experience, so it was clear that stewardship of the environment and sustainability would be central to the design and construction of the new campus. And maintaining the established scale was a priority — certainly for neighbors, but also for the administration, which was keen to be budget-conscious, efficient, and streamlined. The campus footprint was dictated by the original school’s position on the site, while existing trees determined where open spaces could be situated. The original buildings totaled approximately 9,000 sf, and adding a second story to the largest structure on the site allowed for an additional 3,000 sf. The size and siting of the new school, as well as its simple form and straightforward use of brick, all recall the original building. The result is a campus defined by its outdoor areas. In fact, 60 percent of the site is usable outdoor space — a trade-off for keeping the footprint small and not building a space-grabbing cafeteria, gym, or library. The campus has no enclosed corridors or stairs; girls eat lunch outside; they play and take physical education classes around campus; and the classroom experiences often take place outdoors.

Design details throughout the campus focus on multipurpose functionality. Low retaining walls serve as continuous seating. *Pilots* are perfect for playing around and spinning on. The buildings and their interstitial spaces can be used spontaneously, enhancing the community life of the campus. The ground-floor spaces are used by the lower school, while the second-story spaces — including the rooftop garden and “treehouse” — are the exclusive province of the middle school. Each lower school classroom has its own dedicated library nook and an outdoor teaching space. Although the zip line and water feature envisioned by students did not materialize, kindergarteners have a spot for creating elaborate fairy villages using rocks and wood found on site, and a bioswale that bisects the main courtyard provides hands-on lessons about natural systems.

So much instruction takes place outside, in covered and uncovered areas, that conditioned space of 12,400 sf accommodates the entire school, including spaces dedicated to music and art, administrative offices, and a 1,200-sf multiuse building, which has an overhead door and a generous porch and has become the school’s central indoor/outdoor gathering space. A unique new amenity, it is used for performances, activities, and community meetings.

Sustainable design was a priority from the outset, with teachers and parents setting goals for energy efficiency, indoor air quality, and reduced water usage. GSA received a four-star rating from the Austin Energy Green Building Program, only the second new school campus construction to do so. A 5,000-gallon cistern collects rainwater and air conditioning condensate to irrigate the site. Low-VOC (volatile organic compounds) paints, sealants, and adhesives help maintain indoor air quality. Most of the school’s existing furnishings were reused, reducing the exposure to the off-gassing often associated with new furnishings. Indoor water use and energy use have also been minimized. The school uses 15 percent less water and 20 percent less energy than do other buildings of comparable size. GSA earned innovation points for exemplary performance in construction waste management — 87 percent of construction waste was salvaged or recycled, diverting 550 tons of waste from the landfill — and for sourcing, 86 percent of materials came from Texas providers. The campus’ green design strategies also make their way into the curriculum: Students monitor water levels in the cistern as part of science studies, and they hand-water parts of the landscape, which they also helped to install.

“We knew the campus would be very compact,” said Cowan. “And that fact drove the design of the buildings and ancillary spaces so that they fit neatly into the school’s curriculum as well as responding to the girls’ initial requests for their campus. The project was a great experience for us.”

Lawrence Connolly, AIA, is principal of Connolly Architects in Austin.





## Pilkington **Optiwhite™** low iron glass

No matter how ambitious your latest projects may be, whatever you have in mind you should have Pilkington Special Applications Glass in mind too. Pilkington **Optiwhite™** is so versatile it can be specified for a surprisingly wide range of applications. Our extra-clear, low-iron float glass is virtually colorless and has excellent light transmission, making it the ideal choice for applications where glass edges are visible or where transparency and purity of color are desired. Pilkington **Optiwhite™** ensures a more natural and brighter view.

For more information, please call **800.221.0444**, email us at **buildingproducts.pna@nsg.com**, or visit **www.pilkington.com/na**





# Portfolio: Portable

To assist people on the go, architects are rethinking everyday objects, adding a bit of design to the daily grind. G:Model is a canary yellow pop-up alternative to the omnipresent white tents at farmers' markets and festivals, and the Bundle bag is a stackable multicolored carryall that is a far cry from an off-white canvas tote or an advertisement-covered grocery bag.

**80**

## **A Yellow Pop-Up**

G:Model, Fort Worth  
*Bart Shaw Architect*  
*Rachel Adams*

**84**

## **Bring Your Own Bag**

Bundle Reusable Bags  
*DO.GROUP DESIGN*  
*Catherine Gavin*





## A Yellow Pop-Up

by Rachel Adams

**Project** G:Model

**Clients** Market Vendors / AIA Pop-Up Competition

**Architect** Bart Shaw Architect

**Design and Fabrication Team** Bart Shaw, AIA;  
Lamarr McDonald, AIA; Patricia Shaw; Patrick Thaden

**Photographer** Chad Davis, AIA

The pop-up has become ubiquitous within the urban cultural sphere over the last decade. Pop-up art galleries, museums, retail shops, food markets, and events are all contributing to a new form of retail, and with that comes new architecture supporting the pop-up lifestyle. In fact, the 2014 AIA Small Design Project Competition specifically focuses on this trend. The proposed design problem was to re-imagine the typical farmers' market pop-up tent as a canopy. Building the project was a requirement for the competition winner.

Fort Worth-based Bart Shaw, AIA, couldn't pass up the temptation to participate. His interest in the project stemmed from the simplicity of the program, the need for a collapsible, movable shelter. G:Model, as Shaw calls his temporary, attention-grabbing eight-by-eight-ft yellow canopy, easily met the competition requirements. It cost \$750 to build; once disassembled, it is easily transported using a dolly; it will not blow away — but it is not anchored to the



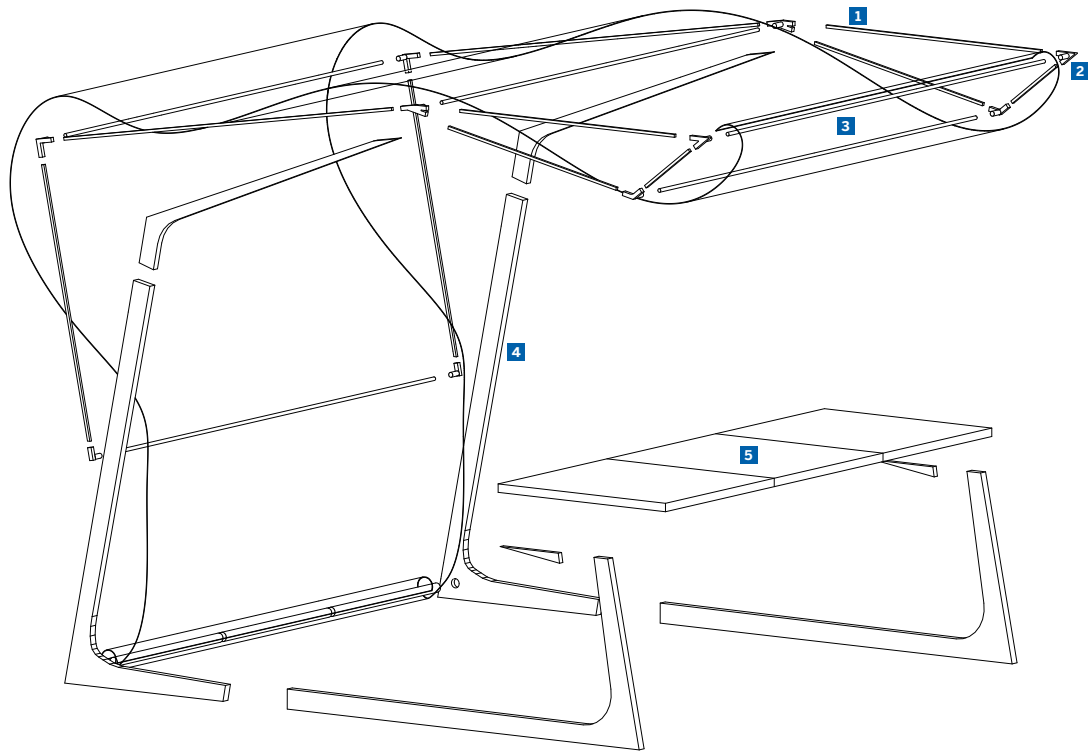

- G-MODEL KEY**
- 1 CARBON FIBER RODS
  - 2 ALUMINUM CONNECTORS
  - 3 NYLON FABRIC
  - 4 ALUMINUM SUPPORTS
  - 5 FOLDABLE TABLE

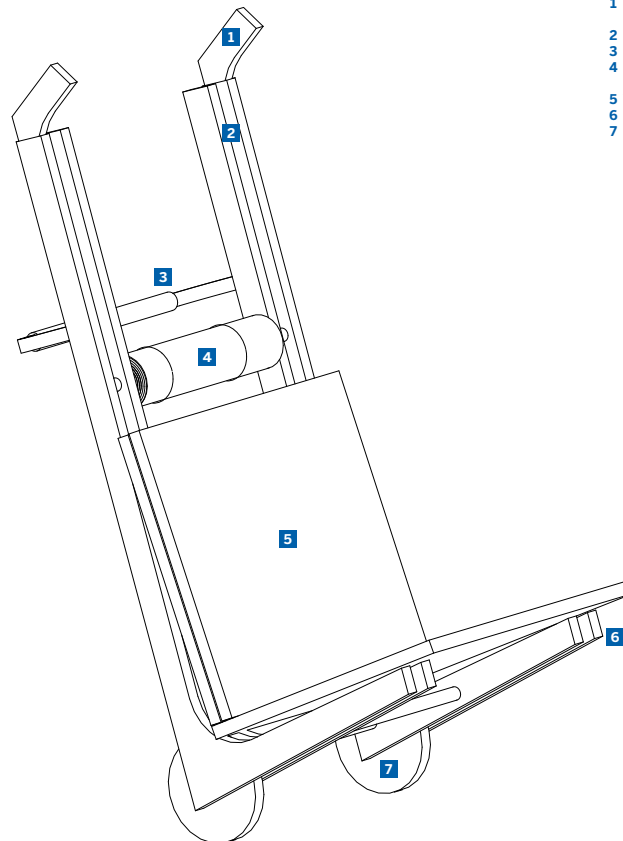
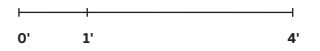

- 1 TOP SUPPORTS STORED IN POSTS
- 2 RODS STORED IN POSTS
- 3 PUSH HANDLE
- 4 FABRIC FOLDED AND SECURED
- 5 TABLE FOLDED
- 6 SUPPORTS
- 7 WHEELS

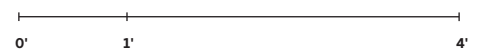



*G:Model presents an alternative to the standard white tents at farmers' markets and festivals. It is easily set up and taken apart, and although it weighs too much to be carried as a folded package, the dolly does the trick to assure G:Model's portability.*







ground; it rises eight ft in the air; and it protects users from the elements.

When Shaw began working on the design for G:Model, he explored the idea of two interacting curves. One would be structural and would lead into the second with a stretched fabric. While the curves eventually straightened out in the design, the idea of two interdependent frames became the basis of the project's conceptual design — one heavy and one light. Shaw thought about the process the vendor would go through from set-up to take-down, while figuring out how the structure could use its own weight so as to anchor itself. The built-in table helps stabilize and adds weight to the structure, eliminating any necessity to tie it to the ground.

Since this competition was about designing and building a pop-up canopy, Shaw worked with several people to fabricate G:Model. He began with sketches and then turned to 3-D modeling to refine the mechanics and analyze the overall form and structure. All of the materials are readily available. The aluminum frame is crafted from tubes, plates, pipes, and rods, which are held together with pins and fasteners for easy assembly and disassembly. The secondary lighter frame is made of fiberglass rods and custom connectors; it allows the fabric canopy to appear to float away from the heavier frame.

Patrick Thaden did the welding and Lamarr McDonald, AIA, cut the steel plate and created the sleeve and frame jigs from the model. The architect's mother, Patricia Shaw, sewed the fabric, which was inspired by the seam patterns of sailboat sails that take into account specific stress points. The fabric is a bright yellow, heavy-duty, UV-protected, tight-woven, rip-stop nylon. It really glows in the changing light, acting very much as a beacon at any time of day.

A contemporary take on the pop-up structure, G:Model can be put together or taken down in only 15 or 20 minutes. And, while the materials are lightweight and current, the feel of the structure is of open-air markets with colorful overhangs and vendors hawking their wares. In one rendering, Shaw shows multiple G:Model units in two long rows with a secondary stretched fabric and frame piece that might transform a street into a continuous, shaded marketplace.

Timely and nice to look at, G:Model could easily find uses beyond the farmers' markets. It is pop-up architecture at its finest.

Rachel Adams is an independent curator based in Austin.



## Bring Your Own Bag

by Catherine Gavin

**Project** Bundle Reusable Bags

**Design Team** DO.GROUP DESIGN: Christopher Ferguson, Assoc. AIA; Megan Marvin

**Photographer** Christopher Ferguson, Assoc. AIA

In March 2013, the City of Austin enacted an ordinance banning single-use carry-out bags. The law regulates the types of bags that can be distributed by businesses and has encouraged a larger cultural shift toward reusable bags. Plastic bags quickly became nonexistent in grocery stores, and bring-your-own-bag campaigns began popping up everywhere. That spring, Christopher Ferguson, Assoc. AIA, and Megan Marvin were ready to graduate from The University of Texas at Austin School of Architecture, and with just a few short months left to go, they decided to make some bags for their final design studio.

The project has grown into a small, promising business. DO.GROUP DESIGN is what they call themselves, and while the two young designers are not quitting their day jobs at architecture firms any time soon, they plan to take their Bundle bags as far as the experiment can go. Ferguson splits his time between Austin and New York, while Marvin spends all her time on the East Coast. The markets, they say, are similar, and the bags have been well received — at larger events such as Brooklyn's Renegade Craft Fair to small neighborhood farmers' markets in New York and Austin. "Actually, we cannot meet the wholesale demand," says Ferguson. "We are still searching for a partner manufacturer that makes sense for us."

Colorful, stackable, and strong, Bundle bags are made out of reinforced matte plastic and expand to accommodate larger objects. They are

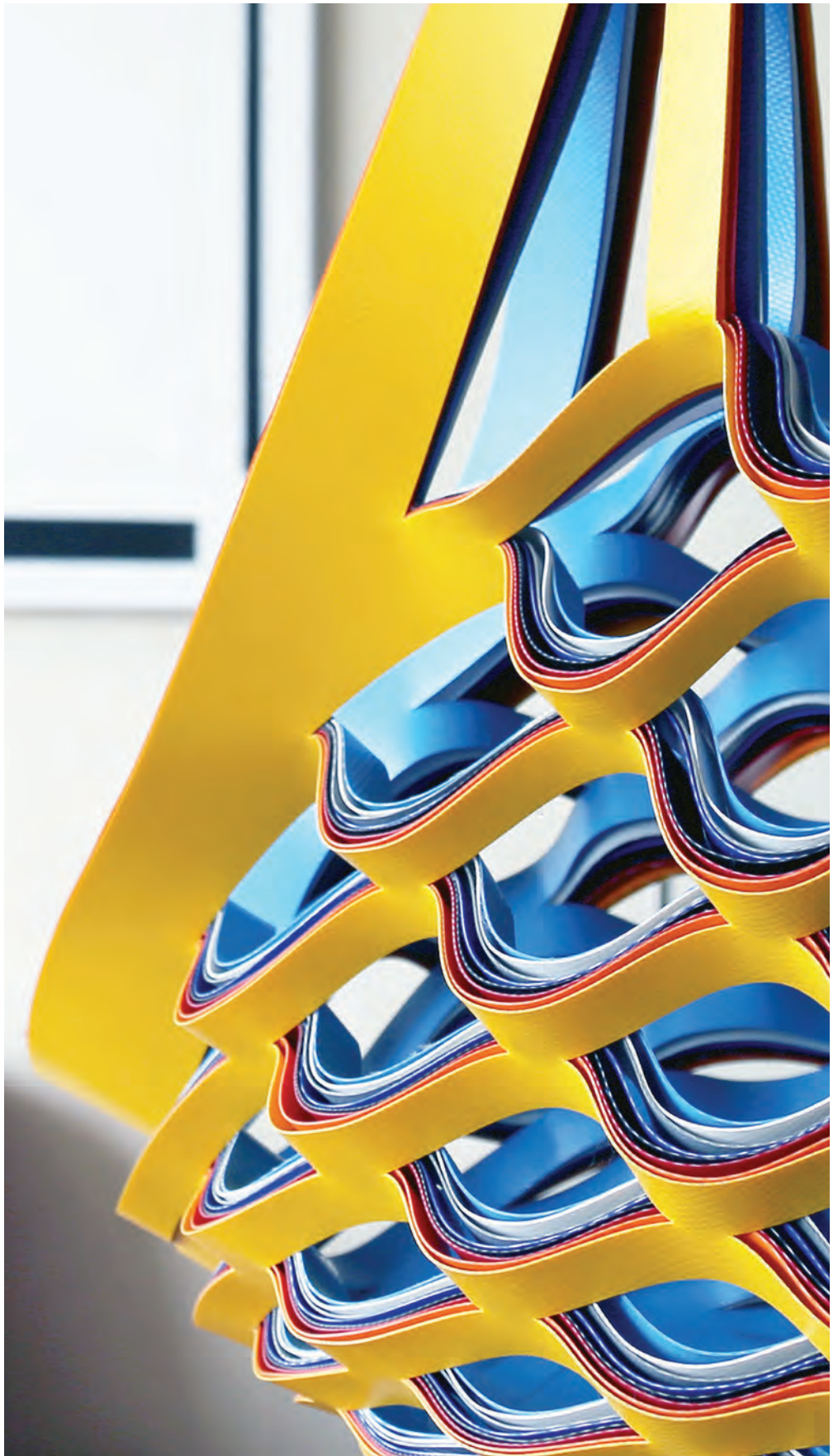





**Opposite page** Bundle bags grew out of a final project for a building materials studio led by Elizabeth Danze, FAIA, and John Blood, AIA, at The University of Texas at Austin. DO.GROUP DESIGN credits Danze and Blood for encouraging them to pursue this project professionally.

**This page** Sheets of reinforced matte plastic are rolled out and then cut with a single-axis die cutter to make the bags, which are easily stacked.

**Following page** Ferguson and Marvin are spending their weekends at festivals and markets selling the bags.

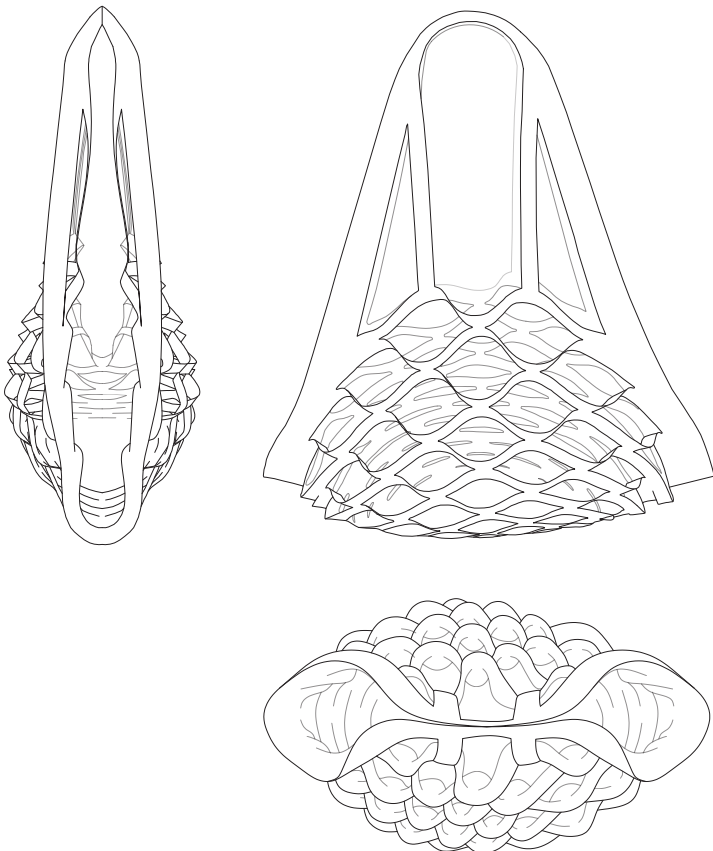





durable: Bundle bags withstand heat, do not tear, and can be easily cleaned by hand with soap and water. The bags work individually or as a group. They can carry up to 20 pounds alone and more when reinforced as a stack.

For Marvin, starting a small business has been eye-opening. “As we grow our tiny venture, I have learned just how essential business and design are to one another,” she says. Shipped from Arizona, sheets of plastic are rolled out and then cut with a single-axis die cutter in Marvin’s Manhattan

studio. The fact that the bags are designed to lie flat streamlined the team’s small home-based manufacturing setup. Small efforts to increase efficiency on the production side, argues Marvin, allow them to focus on growing the business. Ferguson, who worked for Andersson-Wise Architects in Austin before changing jobs to be able to travel between the two cities, emphasizes that without his day job he might not have been able to bring to the table important skills for dealing with suppliers and building client relationships.

“It was invaluable for me to be able to watch Arthur Andersson and Chris Wise at work,” he explains. “Thinking about the business side of design is not something that you walk out of university understanding.” Both Marvin and Ferguson are quick to note, however, that the challenge of the Bundle bag project is worth it. “It is ours, and we are making it grow,” says Ferguson.

Catherine Gavin is editor of *Texas Architect*.





# REDEVELOPMENT



## YOUR IDEA, OUR INGENUITY

What is old can be new again. This is what the owners of 20 Greenway Plaza desired as they redeveloped the property and reintroduced it to the marketplace. Acacia was engaged to create the look of warm wood panels on balconies, stairs and escalators in this classic 10 level office tower. Acacia also manufactured twin backlit Modular Arts feature walls, numerous locations of brilliant green backpainted glass and an elaborate and engaging security desk. The most breathtaking feature was a 4 story elevator shaft clad with the same warm wood panels, thousands of feet of custom stainless steel trim and bright white Interlam dimensional panels.



Team members like Tom Smith review Acacia drawings and carefully coordinate with other plant processes. Tom is a Master Craftsmen who works hard every day to deliver quality, tightly controlled products. Tom plays a significant role in our cross training program, a key element in building the depth of knowledge and ability within the Acacia team.

When we can help you with your big idea, call 877-565-5995 select option #1 or visit us online at [WWW.ACACIAORIGINALS.COM](http://WWW.ACACIAORIGINALS.COM).

  
**ACACIA**  
Integrated Millwork Solutions



# ADVOCATE FOR YOUR PROFESSION ARCHITECTURE MATTERS 2015

**10 FEBRUARY 2015  
ADVOCATES FOR  
ARCHITECTURE DAY  
AUSTIN**

Texas architects will convene at the Texas State Capitol for the third biannual Advocates for Architecture Day.

Join us to meet with state legislators to promote the importance of architecture and design.

**REGISTER ONLINE**  
[texasarchitects.org/advocates](http://texasarchitects.org/advocates)

**Texas  
Society of  
Architects**





## Running with X-acto

written by Canan Yetmen  
 photography by Jeff Wilson

Try to wrap your head around the fact that, in 1950, the average American family lived in a home that was just under 1,000 square feet. By the early 2000s, that average square footage had expanded to just over 2,300. In a mere 50 years, our need for space has expanded more than 100 percent. A sign of affluence and success, the idea of the bigger house as status symbol is also intrinsically woven into the American Dream. It's so ingrained in our identity that our current obesity of space seems inevitable, only a short stop on an inexorable path toward greater vastness. But is that journey reversible? Can we, as Americans — as Texans, even! — choose to downsize intelligently and change our perception of how much legroom we really need?

Scott Specht, AIA, thinks about this a lot. His interest and, ultimately, his success in creating efficient, highly integrated small-scale architecture are not the result of any childhood

*Imagine if your house was designed the same way as a car, where every inch was thought about. You'd need a lot less space, and you'd be a lot more comfortable.*

love for the miniature, as one might expect. Growing up in a standard-issue suburban house in Florida, Specht recalls only a tangential affection for trailers — the usual fascination with the built-in furniture, the integrated fixtures and appliances, the mobility and accompanying self-sufficiency — yet it was apparently enough of a spark to fuel a simmering interest in humans' relationship to space and scale and inquiries into how we might come at such relationships from another angle.

Specht's firm, Specht Harpman Architects, benefits from having two vantage points: With offices in both New York City and Austin, Specht finds himself commuting across state lines on a near-weekly basis, one foot firmly in the crowded streets of the Big Apple, the other kicking dirt in the wide open spaces of the Southwest. It's an odd practice, in his words, and he concedes he's not sure how this current state of affairs came about, except that these are the projects that came to the firm. He and partner Louise Harpman, Assoc. AIA, met at Yale School of Architecture and have built a firm with award-winning rigorous modernist credentials. Early



# Profile

projects, however, were on budgets so tight that Specht would scour neighborhoods for building materials, crafting his own interior wall and ceiling treatments and light fixtures from ice cube trays and soda crates. “It was contextualization at the urban level,” he says. The New York City version of using vernacular materials, it began a career-long experimentation with an architecture that turns our conviction of “bigger is better” on its head.

Along this continuum, Specht has developed conceptual projects that experiment with notions of scale, self-reliance, and efficiency — notably the zeroHouse, a small, prefabricated home that can be deployed, sited, and inhabited in short order, any time, anywhere. The project takes

the kit-of-parts idea to its full measure, creating a structure that is both compact and totally self-sufficient: It collects rainwater, generates its own power, and processes its waste into compost. A sleek, high-tech, and better version of the space-agey Monsanto House of the Future, it can be controlled by any laptop computer. It is an idea perched on the cusp of realization. All that are needed are a shift in our “small-equals-cheap” expectations and a turn toward an understanding of what is truly possible when technology, vision, and innovation guide our thinking, instead.

Given the zeroHouse’s Internet stardom, it seemed inevitable, then, that a client would approach Specht with the real-world renovation of a sixth floor walk-up apartment in Manhattan,

which was a full 425 sf from end to end. What the project had going for it was 25 ft of open vertical space and access to a roof deck. Specht saw an opportunity. “It was a confluence of things that rarely come together: an interesting small space with verticality and the right client,” he said. He envisioned the house, which he calls the Micro-Loft, as a series of connected platforms that move from kitchen, up to a living space, and then to bedroom and, finally, to the roof garden. To add more floor area, the bed is structurally engineered to cantilever above the living space below, and storage is tucked, Japanese-style, into the stairs. As Specht noted, smallness has nothing to do with “doing without.” Creature comforts, thanks to design and technology, are



**Above** *The zeroHouse is a prototype for a self-sufficient modular home that can be easily shipped and constructed on any site.*

**Center left** *The zeroHouse accommodates up to four adults and operates completely off the grid.*

**Bottom left** *The axonometric view shows how the pieces of the Micro-Loft all fit together.*



**Left** *The Manhattan Micro-Loft’s tiny 425-sf footprint rises vertically 25 ft to access a roof terrace.*

**Below** *Integrated storage inspired by Japanese Tansu cabinets maximizes the Micro-Loft’s available space.*



ALL RENDERINGS COURTESY SPECHT HARBMAN ARCHITECTS. PHOTOS OF MICRO-LOFT BY TAGGART SORENSON.





**Left** On the boards for East Austin, Specht is developing a mixed-use project with 12 micro-apartments located above retail/work space. Inspired by the functionality and efficiency of the Manhattan Micro-Loft, the Austin apartments will be between 550 and 550 sf.

**Below** The prairieHouse proposes a retrofit of a gas station for habitation. Living spaces are situated under a broad roof with tall grass growing from it.

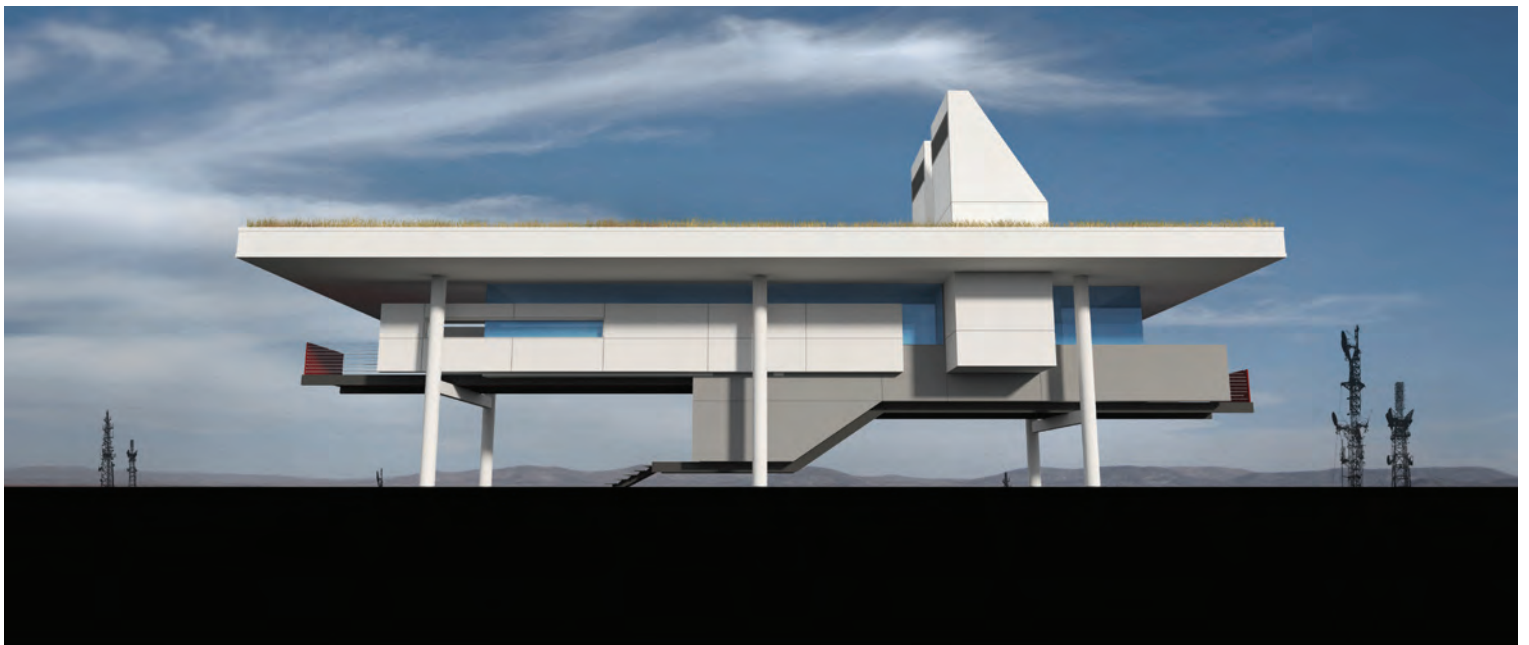

part of the design. “If you think of the design of a car, it is all integrated. Everything you need is in the dashboard. With houses, we put up walls of sheetrock and then wait for something to happen. Imagine if your house was designed the same way as a car, where every inch was thought about. You’d need a lot less space, and you’d be a lot more comfortable.”

Specht also finds opportunities to rethink the repurposing of buildings — adaptive reuse, in conventional parlance. His interest in recycling buildings however, runs deeper, and of course, smaller, too. As part of the global design symposium at New York University in 2011, he created the concept for the prairieHouse, which converts a gas station canopy into a multi-

tiered, small-footprint home. Such projects go beyond mere reuse; they transform the symbols of a bygone time into buildings that push forward, expressing the opposite of the original intent: Thus, a temple of 20th-century consumerism becomes a model for smart conservation.

In the wake of the international attention Specht Harpman received for the Micro-Loft, Specht is now bringing new microlofts to Austin. This one is a new, mixed-use development on the city’s east side, with Specht as both designer and developer. At 10,000 sf, the project contains 12 apartment units between 500 and 550 sf located above retail space. Specht notes that attempting such a small multiuse development in Austin has revealed snags in a building department not yet

used to this type of calculation, although the city’s land prices and construction costs are soaring. The project may well be a harbinger of things to come in the booming Texas capital, at least for those willing to try a new path.

Despite people’s firm attachment to the bigger-as-status-symbol paradigm, Specht does see a rising interest in smaller houses, but suspects that our perceived need for space will take some time to shift. “As with anything, there are people who are interested in living in a different way. Eventually, those ideas filter their way into the mainstream,” he said. “At some point, people will rethink the amount of space we actually need to live in.”

Canan Yetmen is an Austin-based writer.



# Resources

## Nested House, Houston

**Contractor** Streva Construction

**Consultants** **CIVIL ENGINEER:** Karen Rose Engineering & Surveying; **STRUCTURAL ENGINEER:** Insight Engineering

**Resources** **CONCRETE:** Garcia Concrete Contractors; **WOODS, PLASTICS, COMPOSITE:** Stein Wood Products; **OPENINGS:** RAM Windows; **FURNISHINGS:** Internum Furniture

## Sustainable Cabin, Corwell

**Contractor** Students and faculty of Texas Tech University

College of Architecture; College of Engineering; College of Visual and Performing Arts

**Consultants** College of Engineering, Texas Tech University

**Resources** **METAL SIDING, ROOFING:** MBCI; **INTERIOR AND EXTERIOR WOOD CLADDING:** Acacia Hardwoods; **WOOD STUDS, SOLARBOARD:** Lowe's Home Improvement; **FLOORING:** Lumber Liquidator; **RECYCLED COTTON:** Eco Blue; **WINDOWS:** Anderson (Dea Window and Door); **WELDING:** Liberty Welding; **SOLAR ENERGY SYSTEMS:** Therma Breeze Solar Solutions; **WOOD STOVE:** Morso Denmark

## VIA Bus Stop, San Antonio

**Contractor** VIA Metropolitan Transit;

**Consultant** **CIVIL ENGINEER:** Pape-Dawson Engineers; **STRUCTURAL ENGINEER:** Walter P. Moore; **MEP ENGINEER:** HMG & Associates; **LIGHTING:** ArcLight Design; **ACCESSIBILITY:** Altura Solutions; **STEEL FABRICATOR/ERECTOR:** Hill Country Steel

**Resources** **ANTI-GRAFFITI PAINT:** Sherwin-Williams; **LED LIGHT:** Solavanti, Elite Lighting

## MetroRapid Stations, Austin

**Contractor** Muniz Concrete and Contracting

**Consultant** **CIVIL ENGINEER:** URS Corporation; **STRUCTURAL ENGINEER:** URS Corporation; **ELECTRICAL ENGINEER:** URS Corporation

**Resources** **CONCRETE:** Muniz Concrete and Contracting; **STEEL:** NEC Signage and Electrical Products; **ECOCLAD EXTERIOR PANELS:** KlipTech Biotechnologies; **METAL ROOF:** MBCI; **EXTERIOR PAINT:** Sherwin Williams; **BENCH:** Landscape Forms; **TRASH RECEPTACLES:** FairWeather; **EXTERIOR LIGHT FIXTURES:** Elliptipar

## Marfa 10 x 10 Lightbox, Marfa

**Contractor** Quality Finishing

**Resources** **METAL:** Corrugated Metals; **OPENINGS:** Don Young Company

## Kidd Springs Park Pavilion, Dallas

**Contractor** Henneberger Construction

**Consultants** **STRUCTURAL ENGINEER:** MK and Associates

## National Butterfly Center Welcome Pavilion, Mission

**Contractor** Illumina Designers/Builders

**Consultant** **STRUCTURAL ENGINEER:** Vanguard Engineering; **MECHANICAL ENGINEER:** The Alex Group

## The Girls' School of Austin, Austin

**Contractor** American Constructors

**Consultants** **INTERIOR DESIGN:** Edwards+Mulhausen Interior

Design; **STRUCTURAL ENGINEERING:** DCI Engineers; **MEP ENGINEERING:** LaMette Consulting; **LANDSCAPE ARCHITECTURE:** NDLI; **CIVIL ENGINEERING:** Big Red Dog Engineering

**Resources** **CONCRETE:** Central Texas Tiltwall (TXI); **MASONRY:** Featherlite (R&R Masonry); **METAL:** CMC Structural; **THERMAL & MOISTURE PROTECTION:** Fireproof Contractors; **OPENINGS:** Bifold Doors - Schweiss; **FINISHES:** Texas Floor Source, Capitol Blind, Texas Floor Source; **SPECIALTIES:** American Drywall Systems; **PLUMBING:** Ferguson Enterprises (Angell Plumbing); **HEATING, VENTILATING, AND AIR CONDITIONING:** Lennox (Air Craft); **ELECTRICAL:** Big State Electric; **EARTHWORK:** Champion Site Prep

## G:Model, Fort Worth

**Resources** **WELDING:** Patrick Thaden; **ALUMINUM PLATE/TUBE:** Trident Metals; **3DS MAX, AUTOCAD, REVIT:** Novedge



GREIG | PERCY COLLABORATIVE  
ARCHITECTURE & LANDSCAPE ARCHITECTURE  
WWW.GREIGPERCY.COM 512.222.5403

SPEAKING THE LANGUAGE OF ARCHITECTS TO  
HELP THEM UNIFY BUILDINGS AND LANDSCAPE



<b>Acacia Originals</b> ..... 87 877 565 5995 www.acaciaoriginals.com	<b>Grand Openings</b> ..... 8 512 989 9400 mbowles@millworksolutions.com www.grandopenings.com	<b>Peacock Pavers</b> ..... 2-3 800 264 2072 www.peacockpavers.com	<b>Wrightson, Johnson, Haddon &amp; Williams</b> ..... 94 972 934 3700 sfalcone@wjhw.com www.wjhw.com
<b>Acme Brick</b> ..... 4, 34-35 817 332 4101 bseidel@brick.com www.brick.com	<b>Hunt &amp; Joiner</b> ..... 94 214 760 7000 sdial@h-jinc.com www.h-jinc.com	<b>Petersen Aluminum</b> ..... 18 800 722 2523 jsnyder@petersenmail.com www.pac-clad.com	<b>York Metal Fabricators</b> ..... 95 800 255 4703 grantyork@yorkmetal.com www.yorkmetal.com
<b>Blackson Brick</b> ..... BC 214 855 5051 info@blacksonbrick.com www.blacksonbrick.com	<b>Jewell Concrete Products (Oldcastle Architectural Products Group)</b> ..... 16, 42 800 792 3216 jim.paluch@oldcastle.com www.oldcastle.com	<b>Progressive Solutions</b> ..... 10 512 850 9075 mail@werefindinganswers.com www.werefindinganswers.com	
<b>BMC</b> ..... 21, 26 281 569 2579 x525 marvininfo@bmcselect.com www.buildwithbmc.com	<b>L.A. Fuess Partners</b> ..... 94 214 871 7010 mpeterman@lafp.com www.lafp.com	<b>Schuler Shook</b> ..... 95 214 747 8300 dallas@schulershook.com www.schulershook.com	
<b>Boothe Concrete</b> ..... 95 512 454 1641 chris@bootheconcrete.com www.bootheconcrete.com	<b>MEGALITH CADD Services</b> ..... 94 905 473 4090 vj@megalith.net www.caddservices.net	<b>Studio Outside</b> ..... 23 214 934 7160 www.studiooutside.com	
<b>Boral Building Products</b> ..... 1 800 526 7255 boralcs.department@boral.com www.boralbuildingproducts.com	<b>Milgard Windows &amp; Doors</b> ..... 14 800 645 4273 www.milgard.com	<b>Texas Timber Frames</b> ..... 10 210 698 6156 www.texastimberframes.com	
<b>Bury</b> ..... IBC 512 328 0011 kclark@buryinc.com www.buryinc.com	<b>NSG Pilkington</b> ..... 78 419 247 3895 sharon.urban@nsg.com www.nsg.com	<b>The Wagner Companies</b> ..... 26 414 214 0444 mwojtycski@mailwagner.com www.wagnercompanies.com	
<b>Deacero</b> ..... 16 800 332 2376 www.deacero.com		<b>Total CAD Systems</b> ..... IFC 281 445 6161 ppadamada@tcadsys.com www.tcadsys.com	

# Advertise!



**We turn readers into buyers.**

**Texas Architect is the definitive voice of the architecture, design, and construction industry in Texas and beyond.**

Advertise with us and reach architectural firms building all over the nation! No other magazine offers comparable coverage of the architectural profession in the Southwest.

**SPECIAL OFFER**

Buy an ad and receive a free one-year subscription. Start building new business now!

To advertise, contact  
**Krys D'Antonio**  
kdantoni@naylor.com  
503 908 1181





## HUNT & JOINER, INC.

Consulting Structural Engineers

DALLAS: 214-760-7000 [www.h-jinc.com](http://www.h-jinc.com)  
 AUSTIN: 512-358-8788 800-434-3170

Registered in all 48 continental states  
 Innovative structural engineering solutions  
 for over 50 years



L.A. FUESS PARTNERS, INC.

Structural Engineers

[www.lafp.com](http://www.lafp.com)

3333 Lee Parkway  
 Suite 300  
 Dallas, Texas 75219  
 214.871.7010

Mark Peterman PE, Principal  
[mpeterman@LAFP.com](mailto:mpeterman@LAFP.com)

## CAD DRAFTING SERVICES

ASSISTING ARCHITECTS & ENGINEERS FOR 20 YEARS!

NEW DRAWINGS FROM SKETCHES  
 PAPER-TO-CAD CONVERSION  
 DIGITIZING EXISTING DRAWINGS  
 AND OTHER DRAFTING NEEDS

SAVE COSTS!  
 100% MANUALLY DONE!  
 HIGH ACCURACY!  
 FREE SAMPLE WORK!



[www.caddservices.net](http://www.caddservices.net)  
 1.905.473.4090  
[info@megalith.net](mailto:info@megalith.net)

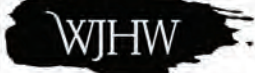

WRIGHTSON, JOHNSON, HADDON & WILLIAMS, INC.

JACK WRIGHTSON  
 PRINCIPAL

RENÉ GARZA  
 ASSOCIATE PRINCIPAL

4801 Spring Valley Road  
 Suite 113  
 Dallas, TX 75244  
 v: 972.934.3700  
 f: 972.934.3720  
 e: [marketing@wjhw.com](mailto:marketing@wjhw.com)  
 i: [www.wjhw.com](http://www.wjhw.com)

SOUND SYSTEMS | AUDIO VISUAL | VIDEO & SCORING DISPLAYS | BROADCAST PROVISIONS & VIDEO PRODUCTION | ACOUSTICS & NOISE CONTROL | THEATRE PLANNING | LIGHTING & RIGGING | DISTRIBUTED TV & SATELLITE | VIDEO SURVEILLANCE & ACCESS CONTROL | TEL/DATA STRUCTURED CABLING

## Trends of the Trade



### Field Constructs Design Competition Early-Bird Registration Ends February 15

Field Constructs Design Competition (FCDC) invites emerging designers, architects, landscape architects, and artists to submit proposals for temporary installations to be sited at the Circle Acres Nature Preserve in Austin, Texas. The international competition will result in the construction of up to five of the entries submitted, which will be selected by a jury of leading figures in architecture, design, and art. The completed installations will open to the public on November 14, 2015 as part of a week-long event series that will promote design and community programming at the site.

Early-bird registration closes on February 15. The entry fee is \$60 for early-bird registration and increases to \$80 after the February 15 deadline. The final registration deadline coincides with the deadline for project entries: April 1.

Competition jurors include:

- Benjamin Ball, Principal, Ball-Nogues Studio, Los Angeles, CA
- Eva Franch, Director, Storefront for Art and Architecture, New York, NY
- John Grade, Artist, Seattle, WA
- Virginia San Fratello, Rael San Fratello/ Emerging Objects, San Francisco, CA
- Jason Sowell, Associate Professor, The University of Texas at Austin, Austin, TX
- Ingrid Spencer, Contributing Editor, Architectural Record, Austin, TX

For more information, see [www.fieldconstructs.org](http://www.fieldconstructs.org).

### Lake|Flato Architects Recognized by Interior Design Magazine



David Lake, FAIA, and  
 Ted Flato, FAIA

Interior Design magazine honorees for its 30th annual Hall of Fame Awards include David Lake, FAIA, and Ted Flato, FAIA, of Lake|Flato Architects. Interior Design's Hall of Fame, established in 1985, recognizes individuals who have made significant contributions to the design industry in such areas as architecture, interior design, furniture design, and product design.



Page/think forward

Page/think forward

Page/think forward

**Page Expands to the West Coast with Focus on Planning**

Page has acquired a well-known San Francisco planning firm, BMS Design Group. This strategic move will enhance the Texas-based firm's urban design, campus planning, and landscape architecture capabilities through the addition of dedicated planning teams with extensive experience in such areas as transit-related projects, streetscapes, and waterfronts.

The new team has worked on a number of prominent public and academic projects in California, including ongoing work on San Francisco's Embarcadero waterfront and numerous University of California campuses. Additionally, Dan Kenney, an award-winning architect and master campus/site planner with four decades of experience, will join Page in the new San Francisco office.

1906 Richcreek Rd.  
Austin, TX 78757  
mobile: 512-736-5006  
office: 512-454-1641  
[bootheconcrete.com](http://bootheconcrete.com)

**BOOTHE  
CONCRETE**

Designs by Mel Lawrence Architects

**YORK METAL FABRICATORS, INC.**  
Custom Ornamental Railing Systems  
Stainless - Aluminum - Brass - Glass

Creative custom fabricated ornamental railings for over 50 years.

**y.m.f.**

[www.yorkmetal.com](http://www.yorkmetal.com) - 800.255.4703 - Oklahoma City, OK

THEATRE PLANNERS  
LIGHTING DESIGNERS  
**Schuler Shook**

Chicago  
Minneapolis  
Dallas

[schulershook.com](http://schulershook.com)





## Music Box

**S**ited on the bank of the West Sister Creek in the Hill Country, the Music Box by John Grable Architects is located just three short miles away from the cypress tree-lined spot that Frederick Law Olmsted declared to be the “prettiest place in Texas” in his 1857 book, “Journey Through Texas.”

The 400-sf building, which doubles as a music room and yoga studio, is a retreat from the property’s main house and takes full advantage of its picturesque setting, opening entirely on two sides. The structure is made of welded oil-field pipe as a tribute to the clients’ family business. And it is finished with reclaimed sinker cypress floors, walls, and ceilings. Custom-designed wall plates provide anchor connections for exercise equipment. The design achieves high acoustical performance and is a serene spot for stretching one’s fingers or limbs. ■



*John Grable Architects designed an inviting open-air music and yoga studio that opens onto the surrounding cypress trees.*



# BURY

SHAPING OUR COMMUNITIES

*Offering a full suite of services including MEP and Structural Design*

WWW.BURYINC.COM



TEXAS | ARIZONA | FLORIDA



# Brilliance in Architectural Masonry

Architects used the right combination of brick and stone, chosen from the widest selection in the region, to artfully remake an entire school's image through a bold new fine arts addition. Flexible, affordable, durable masonry serves equally well as for large expanses and for intricate details. Blackson Brick has assembled an incomparable collection of manufacturers and thousands of masonry options to provide the inspiring palette you need, in both full-bed and thin-set variations. For smart selection, quality, and service across the Southwest, architects **Build Better with Blackson Brick.**

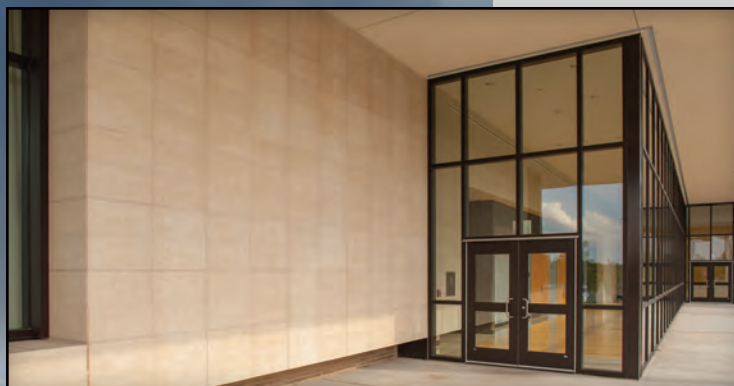

Build Green,  
Build Better:  
Blackson Brick.

AIA Dallas Honor Award Recipient

Broken Arrow South Intermediate High School Broken Arrow OK  
Perkins+Will Dallas design architect  
Selsler Schaefer Architects Tulsa architect of record  
CMSWillowbrook Broken Arrow OK  
Brazeal Masonry Tulsa

**Arriscraft International**

ArrisTile and ArrisClip  
color: Oak Ridge Smooth size: 12x24

**Summit Brick**

color: Twilight size: Norman Full-Bed, Thin-Bed

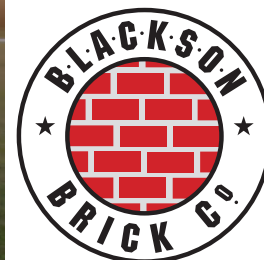

DALLAS SAN ANTONIO  
214.855.5051 210.549.1036  
info@blacksonbrick.com